

EDCON-COMPONENTS



Technical Description

Mode of action: Self Tapping Screw
 Size: M1,4
 Screw Specification: 0,2

Head Type: Head Slotted Countersunk
 Steel Grade: 4,8
 Thread Tol.: ± 0,05mm
 Material: Stainless Steel
 Surface of Thread: Nickel Plated

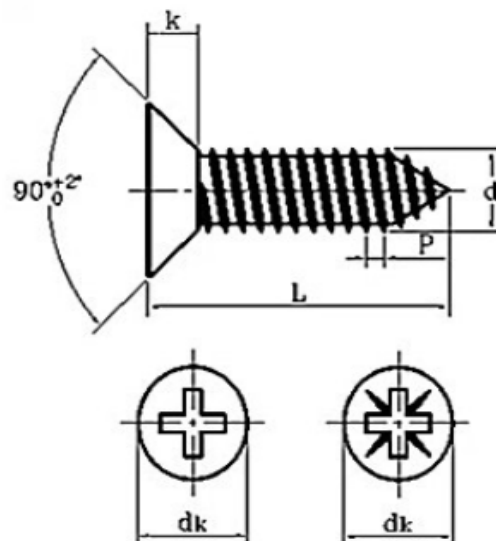

d	1,4	mm
dk	2,43	mm
k	0,98	mm
Angle	90°	

Screw Length Order Code Table

Code	Length	
A01	2,5	mm
A02	3,0	mm
A03	3,5	mm
A04	4,0	mm
A05	4,5	mm
A06	5,0	mm
A07	6,0	mm
A08	8,0	mm
A09		mm
A10		mm
A11		mm
A12		mm
A13		mm
A14		mm
A15		mm
A16		mm
A17		mm
A18		mm
A19		mm
A20		mm

Serie	Length Code	Material	Surface Treatment	Color of Screw	ROHS	Packing
-------	-------------	----------	-------------------	----------------	------	---------

N48014	-	A01	S48	NI	00	R	BU
--------	---	-----	-----	----	----	---	----

Axx= Look order code Table	S48= Steel Material Grade 4,8	NI= Nickel Plated	00= surfaced Colored (Standard)	R= ROHS Conform	BU= Bulk-Ware
			BK= black colored	N= NON ROHS Conform	IV= Individual Package

Self-Tapping Screw Size M1,4

Part No.: **N48014**

DRW:	Jason	CHKD	Wilson	MATL:	Wilson	TOLERANCE	Mason	DATE	27.10.2015
APPD:	Schumi			FINISH	Jamy		Sheet No.		1 from 1

Customer: _____
 email: info@edcon-components.com