



# DATA SHEET

## MLCC Chip Capacitor Size 0603

### Serie: I11004

Mat. Code	<b>NPO</b>	Material: <b>NPO= NPO Material</b>
Voltage Code	<b>160</b>	Voltage: <b>160= 16Volt</b>
Range Code	<b>102</b>	Range: <b>102= 1000pf</b>

**MLCC Chip Capacitor Size  
0603**

Serie No.: **I11004**

Customer:

DRW:	Jason	CHKD	Wilson	MATL:	Wilson	TOLERANCE	Mason	DATE	14.10.2010
APPD:	Schumi			FINISH	Jamy		Sheet No.		1 from 14

# EDCON-COMPONENTS



## Structure of Chip Capacitor

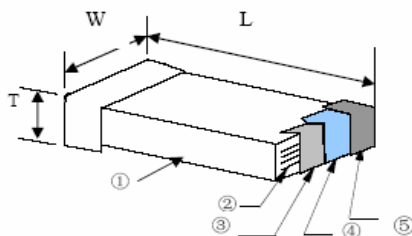

No	Name
1	Ceramic dielectric
2	Inner Electrode
3	Substrate Electrode
4	Nickel Layer
5	Tin Layer

## Nominal Capacitance Unit (pf)

Ordering Code	Actual Value
0P5	0,5pf
1R0	1,0pf
102	1000pf
224	220000pf

Note: The first two digits are significant; third digit denotes number of zeros after range; P= decimal point

## Capacitance Tolerance

Ord. Code	B	C	D	F	G	J	K	M	S	Z
Tolerance	0,1pf	0,25pf	0,5pf	1,0%	2,0%	5,0%	10%	20%	+.50% /-20%	+.80% /-20%

Note: These capacitance tolerance B,C,D are just applicable th capacitance that eqals to or less.

## Dielectric Style

Dielectric Code	CG	HG	LG	PH	RH	SH	TH	UJ	SL	X	B	E	F
Dielectric	COG NPO	HG	LG	PH	RH	SH	TH	UJ	SL	X5R	X7R	Z5U	Y5V

DRW:	Jason	CHKD	Wilson	MATL:	Wilson	TOLERANCE	Mason	DATE	14.10.2010
APPD:	Schumi			FINISH	Jamy		Sheet No.		2 from 14

[www.edcon-components.com](http://www.edcon-components.com)

Copyright by EDCON-COMPONENTS

## Drawing

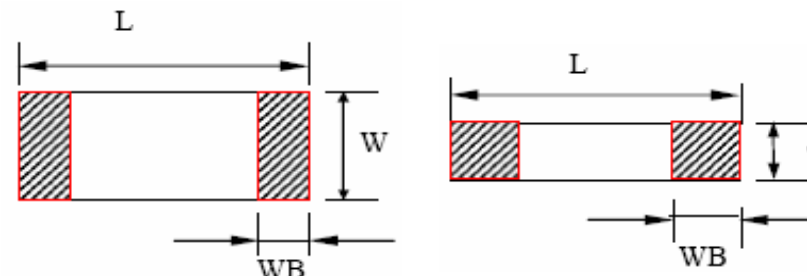

## Dimensions (mm)

Chip-Size Code	L	W	T	WB
0603	1,60	0,80	0,80	0,30

Note: We can design according to customer special requirements

## Rated Voltage (V)

Code	Actual Value
6V3	6,3
500	50
201	200
102	1000

Note: The first two digits are significant; third digit denotes number of zeros after range; P= decimal point

**MLCC Chip Capacitor Size 0603**

Part No.: **I11004**

Customer:

email: [info@edcon-components.com](mailto:info@edcon-components.com)

# EDCON-COMPONENTS



## Terminal Material Styles

Ordering Code	Termination Material
<b>S</b>	(Silver Solderable Termination)
<b>C</b>	(Copper Solderable Termination)
<b>N</b>	(Nickel Barrier Termination)

## Application

Hi-Q COG capacitance are ideally suited for RF and Microwave application requiring high Q, low ESR, and high resonant frequency

## Temperature Coefficient / Characteristics

Dielectric	Temperature Coefficient	Temperature Point
COG/NPO	. 0 +/- 30 ppm/°C	+.20°C > -55°C > +20°C > +125°C
HG	-.33 +/-30 ppm/°C	+.20°C > -55°C > +20°C > +85°C
LG	-.75 +/-30 ppm/°C	+.20°C > -55°C > +20°C > +85°C
CH	0 +/-60 ppm/°C	+.20°C > -55°C > +20°C > +85°C
PH	-.150 +/-60 ppm/°C	+.20°C > -55°C > +20°C > +85°C
RH	-.220 +/-60 ppm/°C	+.20°C > -55°C > +20°C > +85°C
SH	-.330 +/-60 ppm/°C	+.20°C > -55°C > +20°C > +85°C
TH	-.470 +/-60 ppm/°C	+.20°C > -55°C > +20°C > +85°C
UJ	-.750 +/-120 ppm/°C	+.20°C > -55°C > +20°C > +85°C
SL	-.1000 +140 ppm/°C	+.20°C > -55°C > +20°C > +85°C
X7R	. +/-15%	+.20°C > -55°C > +20°C > +125°C
X5R	. +/-15%	+.20°C > -55°C > +20°C > +85°C
Z5U	-.56% ~ +22%	+.20°C > -55°C > +20°C > +85°C
Y5V	-.80% ~ +30%	+.20°C > -55°C > +20°C > +85°C

Note: Nominal Temperature coefficient and allowed tolerance of class 1 are decided by the changing of the capacitance between 20°C and 85°C

## Note for CQ

The following Q value is just confirmed by general customer. If there is a higher requirement for Q value requirements, we can design and produce according to the special requirements.

For the customer whose requirements for frequency is between 1MHz and 2,4GHz or higher frequency, we can design it according to their requirements. The frequency of CQ is a little bit higher than that of CF. Please choose them according to your requirements.

Capacitance (pf)	Q value at 300MHz		Capacitance (pf)	Q value at 300MHz		Capacitance (pf)	Q value at 300MHz	
	O805	O603		O805	O603		O805	O603
4,7	1000	800	11	450	360	24	200	160
5,2	900	720	12	400	320	27	175	140
5,6	850	680	13	375	300	30	150	120
6,2	800	640	14	350	280	33	140	112
6,8	700	560	15	325	260	36	130	104
7,5	650	20	16	300	240	39	120	96
8,2	575	460	18	250	200	43	110	88
9,1	525	420	20	225	180	47	100	80
10	500	400	22	215	172			

**MLCC Chip Capacitor Size 0603**

Part No.: **I11004**

DRW:	Jason	CHKD	Wilson	MATL:	Wilson	TOLERANCE	Mason	DATE	14.10.2010	Customer:
APPD:	Schumi			FINISH	Jamy		Sheet No.	3 from 14		

# EDCON-COMPONENTS



## Note for CF

The following Q value is just confirmed by general customer. If there is a higher requirement for Q value requirements, we can design and produce according to the special requirements.

For the customer whose requirements for frequency is between 1MHz and 2,4GHz or higher frequency, we can design it according to their requirements. The frequency of CQ is a little bit higher than that of CF. Please choose them according to your requirements.

Capacitance (pf)	Q value at 300MHz		Capacitance (pf)	Q value at 300MHz		Capacitance (pf)	Q value at 300MHz	
	O805	O603		O805	O603		O805	O603
4,7	400	320	20	90	72	91	24	20
5,2	36	288	22	86	69	100	22	18
5,6	340	272	24	80	64	110	20	16
6,2	320	256	27	70	56	120	28	15
6,8	280	224	30	60	48	130	16	13
7,5	260	208	33	56	45			
8,2	230	184	36	52	42			
9,1	210	168	39	48	39			
10	200	160	43	44	36			
11	180	144	47	40	32			
12	160	128	51	36	29			
13	150	120	56	34	28			
14	140	112	62	32	26			
15	130	104	68	30	24			
16	120	96	75	28	23			
18	100	80	82	26	20			

## High Voltage MLCC

Middle & High Voltage MLCC is a kind of special design MLCC that bases on the technology of general MLCC. This kind of MLCC has stable high voltage reliability and suitable to SMT. Middle & High Voltage MLCC is widely applicable for many direct high voltage circuits in which it can improve the performance of the circuit.

## Application

Analog & Digital modems  
 LAN & WAN Interface  
 Lighting Ballast Circuits  
 Voltage Multipliers  
 DC-DC-Converter  
 Back-Lighting Inverters

## Measurement Method for High Voltage MLCC

Rated Voltage Range	Measuring Method
500V ≤ Vr ≤ 1000V	Force 150% Rated Voltage for 5seconds. Max. current should not exceed 50mA
1000V ≤ Vr ≤ 2000V	Force 120% Rated Voltage for 5seconds. Max. current should not exceed 50mA
2000V ≤ Vr ≤ 5000V	Force 120% Rated Voltage for 5seconds. Max. current should not exceed 10mA

**MLCC Chip Capacitor Size 0603**

Part No.: **I11004**

DRW:	Jason	CHKD	Wilson	MATL:	Wilson	TOLERANCE	Mason	DATE	14.10.2010	Customer:
APPD:	Schumi			FINISH	Jamy		Sheet No.	4 from 14		

# EDCON-COMPONENTS



## Reliability Test

Item	Technical specification				Test Methods and Remarks			
Capacitance	Class I	Should be within the specified tolerance		Capacitance	Measuring Frequency		Measuring Voltage	
				≤1000pf	1MHz +/- 10%		1,0 Tol. 0,2Vrms	
				≥1000pf	1KHz +/- 10%			
DF, tan Dissipation Favctor	Class II	Should be within the specified tolerance		C≤10μF	Test Frequency 1KHZ +/-10%			
				Test Voltage 1,0 +/- 0,2Vrms				
				X7R, Y5V				
				C>10μF	Test Frequency 1KHZ +/-10%			
				Test Voltage 1,0 +/- 0,2Vrms				
				Z5U				
	Test Frequency 1KHZ +/-10%							
	Test Voltage 1,0 +/- 0,2Vrms							
	Class I	DF≤ 0,15%		Capacitance	Measuring Frequency		Measuring Voltage	
				≤1000pf	1MHz +/- 10%		1,0 Tol. 0,2Vrms	
≥1000pf				1KHz +/- 10%				
Class II	X7R	>50V	25V	16V	10V	6,3V	C= 10μF	
		≤ 2,5%	≤ 3,5%	≤ 3,5%	≤ 5%	≤ 5%	Test Frequency 1KHZ +/-10%	
						≤ 10%	Test Voltage 1,0 +/- 0,2Vrms	
						( C ≥ 3,3μF)		

**MLCC Chip Capacitor Size  
0603**

Part No.: **I11004**

DRW:	Jason	CHKD	Wilson	MATL:	Wilson	TOLERANCE	Mason	DATE	14.10.2010	Customer:
APPD:	Schumi			FINISH	Jamy		Sheet No.	5 from 14		

# EDCON-COMPONENTS



## Reliability Test

DF, tan Dissipation Factor	Class II	Y5V / Z5U	≥25V	16V	10V	6,3V	C= 10μF X7R; Y5V		
			≤ 7,0%	≤12,5%	≤12,5%	≤12,5%	Test Frequency 120Hz +/-20Hz		
			( C < 1,0μF)				Test Voltage 0,5 +/- 0,1Vrms		
			≤ 9,0%				Test Frequency 0,1KHz		
( C ≥ 1,0μF)	Test Voltage 0,5 +/- 0,05Vrms								
(IR) Insulation Resistance	Class I	C ≤ 10nf, Ri ≥ 50000MΩ C > 10nf, Ri ≥ 500S					Measuring Voltage: Rated Voltage Duration: 60Sec. +/- 5s		
									Class II
	Y5V / Z5U	C ≤ 25nf, Ri ≥ 4000MΩ C > 25nf, Ri ≥ 100S							
		Item							Technical Specification
(DWV) Dielectric Withstanding Voltage	No Breakdown or damage				Measuring Voltage: Class I: 300% Rated Voltage Class II: 250% Rated Voltage Duration : 5 +/-1sec Charge / Discharge Current : 50mA max. This method excludes high voltage MLCC				
Solderability	At least 95% of the terminal electrode is covered by new solder. Visual Appearance: No visible damage:				Solder Temperature: 235°C +/- 5°C Duration : 2 +/-0,5sec				

<b>MLCC Chip Capacitor Size</b>
<b>0603</b>
Part No.: <b>I11004</b>

DRW:	Jason	CHKD	Wilson	MATL:	Wilson	TOLERANCE	Mason	DATE	14.10.2010	Customer:
APPD:	Schumi			FINISH	Jamy		Sheet No.	6 from 14		

# EDCON-COMPONENTS



## Reliability Test

Resistance to Soldering Heat	Item	NPO to SL	X7R	Y5V	Z5U	Preheating conditions: 100 to 200°C +/- 10°C 2mon. Solder Temperature: 265°C +/- 5°C Duration 5sec. +/- 1sec. Clean the capacitor with solvent and examine it with a 10x(min) microscope. Recovery time : 24hrs +/-2hrs Recovery conditions: Room temperature
	C/C	≤ 0,5%	. -5 ~ +10%	. -10 ~ +20%		
	DF	Same to initial Value				
	IR	Same to initial Value				
	Apperance: No visible damage. At least 95% of the terminal electrode is covered by new solder.					
Resistance to Flexure of Substrate ( Bending Strength)	Apperance: No visible damage.					<p>Test Board: Al2O3 or PCB                  Wrap: 1mm                  Speed 0,5mm/sec.                  Unit: mm                  The measurement should be mader with the board in bending position.</p>
	C/C	≤ +/- 10%				

**MLCC Chip Capacitor Size 0603**

Part No.: **I11004**

DRW:	Jason	CHKD	Wilson	MATL:	Wilson	TOLERANCE	Mason	DATE	14.10.2010
APPD:	Schumi			FINISH	Jamy		Sheet No.	7 from 14	Customer:

# EDCON-COMPONENTS



## Reliability Test

Item	Technical specification		Test Methods and Remarks															
Termination Adhesion	No visible damage		Applied Force: 5N Duration: 10sec +/- 1sec															
Temperature Cycle	Class I : $\leq \pm 1\%$ or 1pf whichever is larger. Class II: B: $\leq \pm 10\%$ E,F: $\leq \pm 20\%$		Preheating conditions: up-category temperature 1hrs Recovery time: 24hrs +/-1hrs Initial Measurement Cycling Tiems 5times, 1cycle, 4steps															
			<table border="1"> <thead> <tr> <th>Step</th> <th>Temperature (°C)</th> <th>Time (min)</th> </tr> </thead> <tbody> <tr> <td>1</td> <td>Low-category temp. (NPO / X7R / Y5V / Z5U)</td> <td>30</td> </tr> <tr> <td>2</td> <td>Normal Temp. (+20)</td> <td>2~3</td> </tr> <tr> <td>3</td> <td>Up-category temp. (NPO / X7R / Y5V / Z5U)</td> <td>30</td> </tr> <tr> <td>4</td> <td>Normal Temp. (+20)</td> <td>2~3</td> </tr> </tbody> </table>	Step	Temperature (°C)	Time (min)	1	Low-category temp. (NPO / X7R / Y5V / Z5U)	30	2	Normal Temp. (+20)	2~3	3	Up-category temp. (NPO / X7R / Y5V / Z5U)	30	4	Normal Temp. (+20)	2~3
			Step	Temperature (°C)	Time (min)													
			1	Low-category temp. (NPO / X7R / Y5V / Z5U)	30													
			2	Normal Temp. (+20)	2~3													
3	Up-category temp. (NPO / X7R / Y5V / Z5U)	30																
4	Normal Temp. (+20)	2~3																
Recovery time after test 24hrs +/- 2hrs																		
<table border="1"> <tbody> <tr> <td rowspan="3">C/C</td> <td>Class I <math>\leq \pm 2\%</math> or 1pf whichever is larger</td> <td rowspan="3">Temperature: 40°C +/-2°C Humidity: 90~95% RH Voltage: Rated Voltage Duration: 500hrs Charge/Discharge Current: 50mA max. Recovery Time; 24hrs (Class I) or 48hrs (Class II)</td> </tr> <tr> <td>Class II B: <math>\leq \pm 10\%</math></td> </tr> <tr> <td>Class II E,F: <math>\leq \pm 30\%</math></td> </tr> <tr> <td>DF</td> <td>Not more than twice of initial value</td> <td></td> </tr> <tr> <td rowspan="2">IR</td> <td>Class I: <math>R_i \geq 2500M\Omega</math> <math>R_i/C_r \geq 25sec</math> whichever is smaller</td> <td></td> </tr> <tr> <td>Class II: <math>R_i \geq 1000M\Omega</math> <math>R_i/C_r \geq 25sec</math> whichever is smaller</td> <td></td> </tr> <tr> <td colspan="3">Visual Apperance: No visible damage</td> </tr> </tbody> </table>			C/C	Class I $\leq \pm 2\%$ or 1pf whichever is larger	Temperature: 40°C +/-2°C Humidity: 90~95% RH Voltage: Rated Voltage Duration: 500hrs Charge/Discharge Current: 50mA max. Recovery Time; 24hrs (Class I) or 48hrs (Class II)	Class II B: $\leq \pm 10\%$	Class II E,F: $\leq \pm 30\%$	DF	Not more than twice of initial value		IR	Class I: $R_i \geq 2500M\Omega$ $R_i/C_r \geq 25sec$ whichever is smaller		Class II: $R_i \geq 1000M\Omega$ $R_i/C_r \geq 25sec$ whichever is smaller		Visual Apperance: No visible damage		
C/C	Class I $\leq \pm 2\%$ or 1pf whichever is larger	Temperature: 40°C +/-2°C Humidity: 90~95% RH Voltage: Rated Voltage Duration: 500hrs Charge/Discharge Current: 50mA max. Recovery Time; 24hrs (Class I) or 48hrs (Class II)																
	Class II B: $\leq \pm 10\%$																	
	Class II E,F: $\leq \pm 30\%$																	
DF	Not more than twice of initial value																	
IR	Class I: $R_i \geq 2500M\Omega$ $R_i/C_r \geq 25sec$ whichever is smaller																	
	Class II: $R_i \geq 1000M\Omega$ $R_i/C_r \geq 25sec$ whichever is smaller																	
Visual Apperance: No visible damage																		
Moisture Resistance	Class I $\leq \pm 2\%$ or 1pf whichever is larger		Temperature: 40°C +/-2°C Humidity: 90~95% RH Voltage: Rated Voltage Duration: 500hrs Charge/Discharge Current: 50mA max. Recovery Time; 24hrs (Class I) or 48hrs (Class II)															
	Class II B: $\leq \pm 10\%$																	
	Class II E,F: $\leq \pm 30\%$																	
	Not more than twice of initial value																	
Class I: $R_i \geq 2500M\Omega$ $R_i/C_r \geq 25sec$ whichever is smaller																		
Class II: $R_i \geq 1000M\Omega$ $R_i/C_r \geq 25sec$ whichever is smaller																		
Visual Apperance: No visible damage																		

Note: Pretreatment (only for class 2 capacitor)

Pretreatment (only for class 2 capacitor) is a method to treat the capacitor before measurement. First place the capacitor in the up-category temperature or other specified higher temperature environment for 1 hour. Then recovery the capacitor at standard pressure conditions for 24hours +/-1hrs..

**MLCC Chip Capacitor Size  
0603**

Part No.: **I11004**

DRW:	Jason	CHKD	Wilson	MATL:	Wilson	TOLERANCE	Mason	DATE	14.10.2010
APPD:	Schumi			FINISH	Jamy		Sheet No.	8 from 14	Customer:

[www.edcon-components.com](http://www.edcon-components.com)

email: [info@edcon-components.com](mailto:info@edcon-components.com)



# EDCON-COMPONENTS



## Package Conditions



Dimension of paper taping for size 0603, 0805, 1206

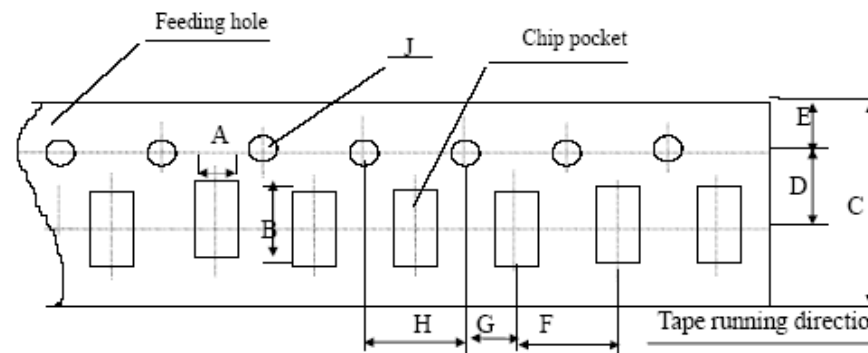

Dimension of paper taping for size 0402

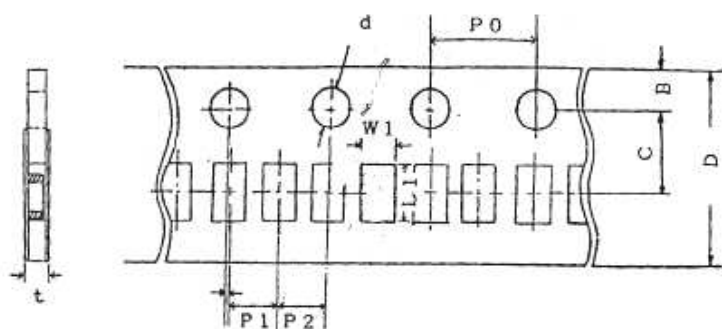

Paper Size Size Code	A	B	C	D	E	F	G	H	J	T
0603	1,10 ±0,20	1,90 ±0,20	8,00 ±0,20	3,50 ±0,05	1,75 ±0,10	4,00 ±0,10	2,00 ±0,10	4,00 ±0,10	1,50 ±0,10	1,10 below
0805	1,45 ±0,20	2,30 ±0,20	8,00 ±0,20	3,50 ±0,05	1,75 ±0,10	4,00 ±0,10	2,00 ±0,10	4,00 ±0,10	1,50 ±0,10	1,10 below
1206	1,80 ±0,20	3,40 ±0,20	8,00 ±0,20	3,50 ±0,05	1,75 ±0,10	4,00 ±0,10	2,00 ±0,10	4,00 ±0,10	1,50 ±0,10	1,10 below

Code	W1	L1	D	C	B	P1	P2	P0	d	t
0402	0,65	1,15	8,0	3,5	1,75	2	2	4	1,5	0,8
	±0,20	±0,20	±0,20	±0,05	±0,10	±0,05	±0,05	±0,05	±0,10	below

**MLCC Chip Capacitor Size 0603**

Part No.: **I11004**

DRW:	Jason	CHKD	Wilson	MATL:	Wilson	TOLERANCE	Mason	DATE	14.10.2010
APPD:	Schumi			FINISH	Jamy		Sheet No.	9 from 14	Customer:



## Package Conditions

Dimension of paper taping for size 0805 ~ 1812



Paper Size Size Code	A	B	C	D	E	F	G	H	J	T
0805	1,55 ±0,20	2,35 ±0,20	8,00 ±0,20	3,50 ±0,05	1,75 ±0,10	4,00 ±0,10	2,00 ±0,10	4,00 ±0,10	1,50 ±0,10	1,50 below
1206	1,95 ±0,20	3,60 ±0,20	8,00 ±0,20	3,50 ±0,05	1,75 ±0,10	4,00 ±0,10	2,00 ±0,10	4,00 ±0,10	1,50 ±0,10	1,50 below
1210	2,70 ±0,10	3,42 ±0,10	8,00 ±0,10	3,50 ±0,05	1,75 ±0,10	4,00 ±0,10	2,00 ±0,10	4,00 ±0,10	1,55 ±0,10	1,55 ±0,10
1808	2,20 ±0,10	4,95 ±0,10	12,00 ±0,10	5,50 ±0,05	1,75 ±0,10	4,00 ±0,10	2,00 ±0,10	4,00 ±0,10	1,50 ±0,10	1,80 ±0,10
1812	3,66 ±0,10	4,95 ±0,10	12,00 ±0,10	5,50 ±0,05	1,75 ±0,10	8,00 ±0,10	2,00 ±0,10	4,00 ±0,10	1,55 ±0,10	1,85 ±0,10

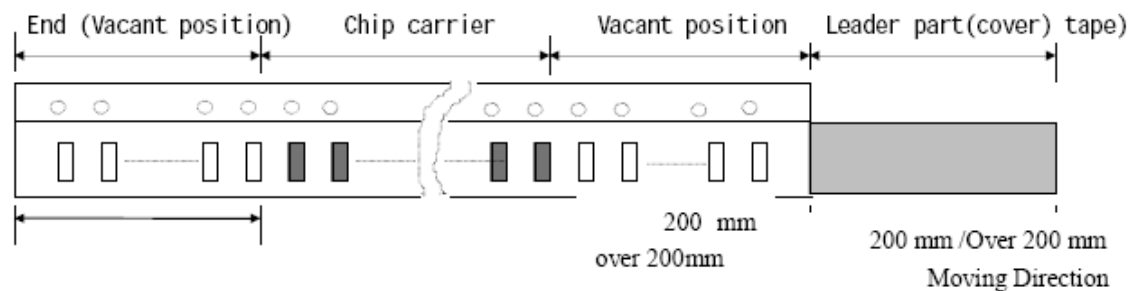

**MLCC Chip Capacitor Size 0603**

Part No.: **I11004**

DRW:	Jason	CHKD	Wilson	MATL:	Wilson	TOLERANCE	Mason	DATE	14.10.2010
APPD:	Schumi			FINISH	Jamy		Sheet No.	10 from 14	Customer:

# EDCON-COMPONENTS



## Package Conditions



Dimension of Reel (mm)

	A	B	C	D	E	F	G
7' Reel	Ø178 ± 2,0	3,0	Ø13 ± 0,5	Ø21 ± 0,8	Ø50 or more	Ø10 ± 1,5	12 max.
13' Reel	Ø330± 2,0	3,0	Ø13 ± 0,5	Ø21 ± 0,8	Ø50 or more	Ø10 ± 1,5	12 max.

## Taping Specification

Paper Taping



Embossed Taping



Standard: 0,1N < peeling strength < 0,7N

No paper dirty remains on the scotch when peeling, and sticks to top an bottem tape

**MLCC Chip Capacitor Size  
0603**

Part No.: **I11004**

DRW:	Jason	CHKD	Wilson	MATL:	Wilson	TOLERANCE	Mason	DATE	14.10.2010
APPD:	Schumi			FINISH	Jamy		Sheet No.		11 from 14

Customer:

# EDCON-COMPONENTS



## Packing Quantity

Size	Packing Style Quantity			
	PT	ET	BC	BP
0402	10000	-----	20000	5000
0603	5000	-----	15000	5000
0805	5000	2500	10000	5000
1206	5000	2500	5000	5000
1210	-----	2000	-----	2000
1808	-----	2000	-----	2000
1812	-----	2000	-----	2000
2225	-----	-----	-----	500
3035	-----	-----	-----	-----

Note: We can choose packing style and quantity can be according to the customer requirement

## Soldering Informations

### Storage Methods

The guaranteed period for solderability is 6 month ( Under deliver package conditions).

Storage conditions:

Temperature: 5~40°C

Relative Humidity: 20~70%

### Precautions for use

The Multilayer Ceramic Capacitor (MLCC) may fail in a short circuit mode in an open circuit mode when subjected to severe conditions of electrical and / or mechanical stress beyond the specified rating and specified conditions in the specification, which will result in burn out, flaming or glowing in the worst case.

Following precautions for safety and Application Notes shall be taken in your major consideration. If you have a question about the precautions for handling, please consult our engineering department of our factory.

### Manual Soldering

Manual Soldering can pose a great risk of ceramic thermal cracks in capacitors. The hot soldering iron tip comes into direct contact with the end terminations, and operator carelessness may cause the tip of the soldering iron to come into direct contact with the ceramic body of the capacitor. Therefore the soldering iron must be handled carefully, and pay much attention to the selection of the soldering iron tip and temperature contact of the tip.

**MLCC Chip Capacitor Size  
0603**

Part No.: **I11004**

DRW:	Jason	CHKD	Wilson	MATL:	Wilson	TOLERANCE	Mason	DATE	14.10.2010
APPD:	Schumi			FINISH	Jamy		Sheet No.		12 from 14

Customer:



Soldering Profile Curve

Classification Reflow Profile (JEDEC J-STD-020C)



Too much solder  
Cracks tend occur due to large stress

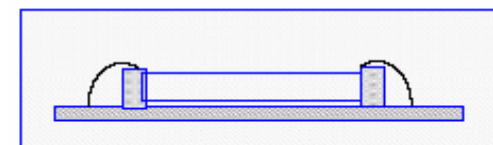

Not enough solder  
Weak holding force may cause bad connection between the capacitor and PCB

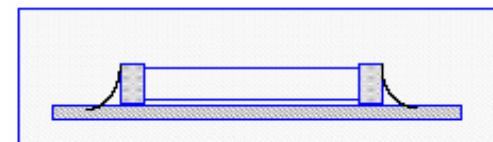

**MLCC Chip Capacitor Size 0603**

Part No.: **I11004**

DRW:	Jason	CHKD	Wilson	MATL:	Wilson	TOLERANCE	Mason	DATE	14.10.2010
APPD:	Schumi			FINISH	Jamy		Sheet No.		13 from 14

Customer:

# EDCON-COMPONENTS



## Ordering Information

Serie	Range	Material	Voltage	Capacitance Tolerance	Termination Material	No Function	No Function	ROHS	Packing	
-------	-------	----------	---------	-----------------------	----------------------	-------------	-------------	------	---------	--

<b>I11004</b>	<b>102</b>	<b>NPO</b>	<b>160</b>	<b>J</b>	<b>S</b>	<b>N</b>	<b>N</b>	<b>R</b>	<b>TR</b>	
---------------	------------	------------	------------	----------	----------	----------	----------	----------	-----------	--

MLCC Chip Capacitor Size 0603	<b>102=</b> 1000pf	<b>NPO=</b> NPO Material	<b>160=</b> 16Volt	<b>J=</b> Tol. 5%	<b>S=</b> Silver Termination	<b>N=</b> No Function	<b>N=</b> No Function	<b>R=</b> Rohs Conform	<b>TR=</b> Tape / Reel
				<b>G=</b> Tol. 2%	<b>C=</b> Copper Termination				
				<b>F=</b> Tol. 1%	<b>N=</b> Nickel Termination				
				<b>D=</b> Tol. 0,5pf					
				<b>C=</b> Tol. 0,25pf					
				<b>B=</b> Tol. 0,1pf					
			Tol.Code <b>B,C,D</b> are only for $\leq 10$ pf						

**MLCC Chip Capacitor Size 0603**

Part No.: **I11004**

DRW:	Jason	CHKD	Wilson	MATL:	Wilson	TOLERANCE	Mason	DATE	14.10.2010
APPD:	Schumi			FINISH	Jamy		Sheet No.		14 from 14

Customer: