

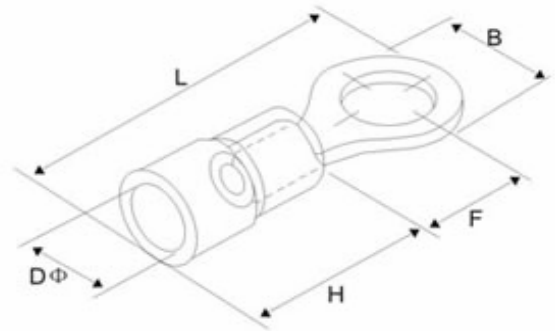

Technical Specification

Maximum Electrical Ratings:	75°C / 600V
Maximum Electrical Ratings:	22-16AWG/ 0,5-1,5mm ² 19A
	16-14AWG/ 1,5-2,5mm ² 27A
	14-12AWG/ 2,5-4,0mm ² 37A
	12-10AWG/4-6mm ² 48A
Terminal Body:	Copper
Insulation:	Nylon
Plating:	Tin
VIM--- Flared Nylon without copper sleeve	
PIPG-- Pre insulated funnel Nylon insulator with easy entry copper sleeve	

Technical Drawing



This Dimension are for 14~12AWG / 2,5~4,0mm²

Order Code	Stud Size	d2	B	L	F	H	DØ									Color
A0	#8	4,3	8,0	24,5	7,7	12,5	6,2									Black
A1	#10	5,3	8,0	24,5	7,7											
A2	#10	5,3	12,0	27,9	7,7											
A3	1/4	6,5	12,0	27,9	7,7											
A4	5/16	8,5	15,0	32,0	13,5											
A5	3/8	10,5	15,0	32,0	13,5											
A6	1/2	13,0	19,2	38,1	16,0											
A7																
A8																
A9																
B0																
B1																
B2																
B3																
B4																

Ordering Information

Serie	Order Code	ROHS	Packing			
N38032	A0	R	BU102			

look table	R= ROHS conform	BU102 1000PCs in one poly bag
	N= Non ROHS conform	

Round Terminal Vinyl Insulated	
Part No.:	N38032
Customer:	

DRW:	Jason	CHKD	Jules	MATL:	Wu	DATE	08.09.2009
APPD:	Join			FINISH	Shieh	Sheet	1 from 1