

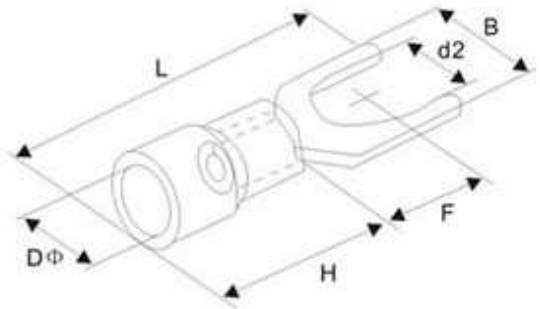

Technical Specification

Maximum Electrical Ratings:	75°C / 600V
Maximum Electrical Ratings:	22-16AWG/ 0,5-1,5mm ² 19A
	16-14AWG/ 1,5-2,5mm ² 27A
	14-12AWG/ 2,5-4,0mm ² 37A
	12-10AWG/4-6mm ² 48A
Terminal Body:	Copper
Insulation:	Nylon
Plating:	Tin
VIM--- Flared Nylon without copper sleeve	
PIPG-- Pre insulated funnel Nylon insulator with easy entry copper sleeve	

Technical Drawing



This Dimension are for 12~10AWG / 4,0/6,0mm²

Order Code	Stud Size	d2	B	L	F	H	DØ							Color
A0	#6	3,7	8,3	25,2	7,5	12,5	6,7							Yellow
A1	#8	4,3	8,3	25,2	7,5									
A2	#8	4,3	9,0	25,2	7,5									
A3	#10	5,3	9,0	25,2	7,5									
A4	1/4	6,5	9,0	25,2	7,5									
A5	1/4	6,5	12,0	31,2	12,0									
A6	5/16	8,5	14,0	30,0	11,5									
A7														
A8														
A9														
B0														
B1														
B2														
B3														

Ordering Information

Serie	Order Code	ROHS	Packing			
N38004	A0	R	BU102			

look table	R= ROHS conform	BU102 1000PCs in one poly bag
	N= Non ROHS conform	

Furcate Terminal Vinyl Insulated	
Part No.:	N38004
Customer:	

DRW:	Jason	CHKD	Jules	MATL:	Wu	DATE	08.09.2009
APPD:	Join			FINISH	Shieh	Sheet	1 from 1