



Technical Specification

Shell Cover: Steel Nickel Plated
 GND Cont: Phosphor Bronze, NICKEL plated

Housing: ABS
 Terminals: Copper, Silver plated

Rating: 100VAC 1A max.
 Contact Resistance: Pin 30m Ohm max.
 Shell 50m Ohm max.
 Insulation Resistance: 100M Ohm at 500VDC min.
 Voltage Withstanding: 250VAC for 1 minute

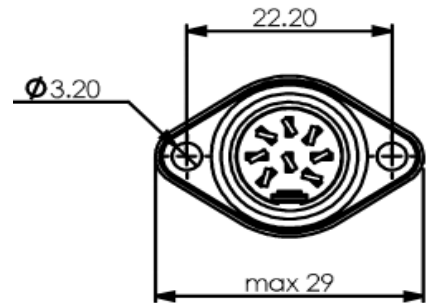
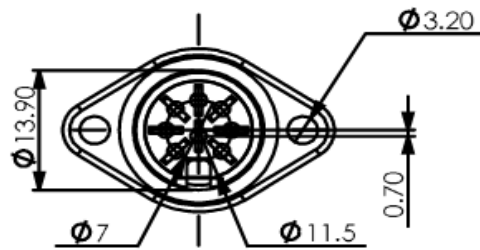
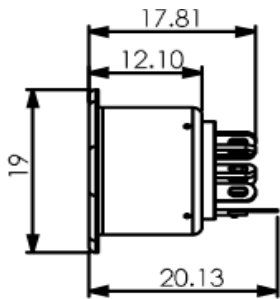

Pos.



Ordering Information

Serie	Pos.	ROHS	Packing			
T20E010	4	R	B			

No. of Position	N = non ROHS	B = Bulk-Ware	
	R = ROHS	IN = individuell	

DIN CHASSIS MOUNT METALL FLANGE	
Part No.:	T20E010
Customer:	

DRW:	Jason	CHKD	Jules	MATL:	Wu	DATE	12.09.2023
APPD:	Join			FINISH	Shieh	Sheet	1 from 1