

EDCON-COMPONENTS

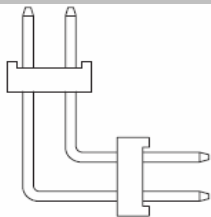

Specifications

Current Rating:	1,5 Ampere
Insulator Resistance:	5000 Megaohm min.
Dielectric Withstanding:	AC 500V
Operating Temperature:	.-40°C to +105°C
Contact Material:	Copper, Alloy
Insulator Material:	P.B.T / PA6T
Standard:	PBT
Contact Plating:	Tin, Gold or Selective Plated
Standard:	Gold Flash Overall
Selectiv Plating:	Gold flash plated on contact area / tin plated on solder area
Max. Processing Temp.	230°C for 60 seconds

P.C.B Layout

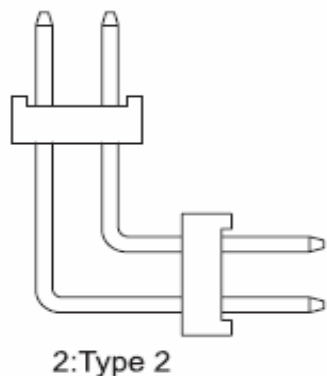
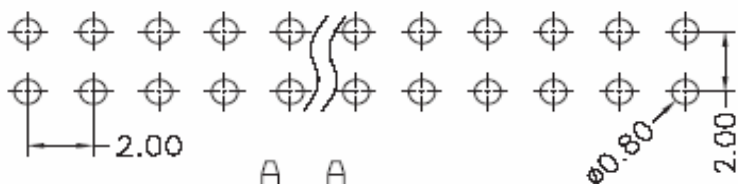

Drawing (dimensions all into mm)

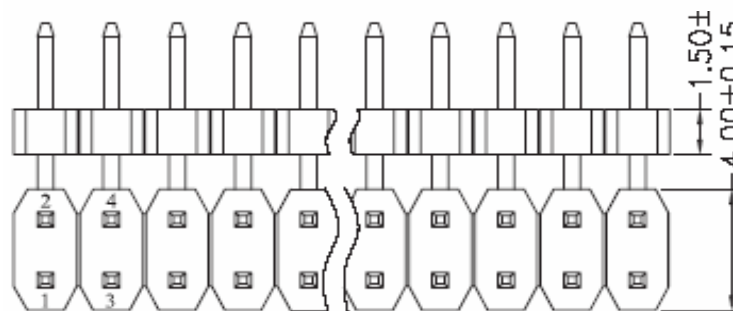
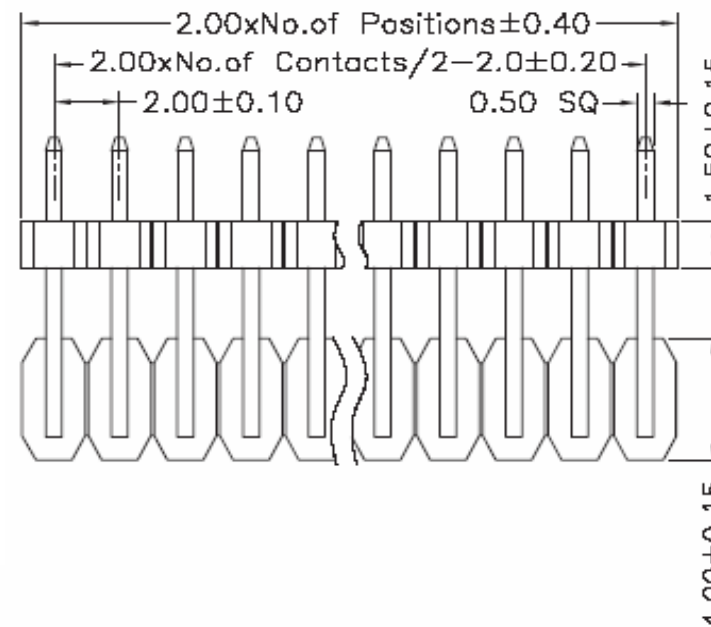
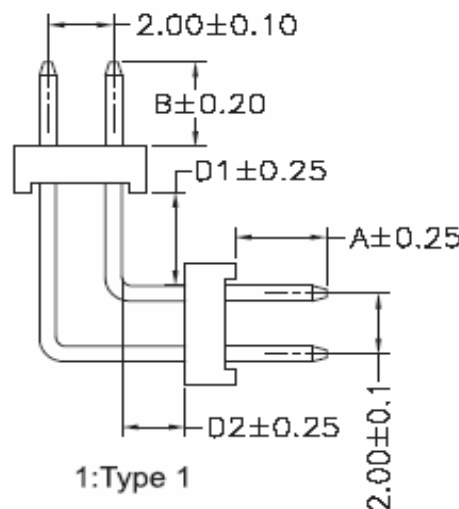

PIN Header / Dual Row / Dual Body / Pitch 2,00mm	
Part No.:	T51B1038
Customer:	

DRW:	Jason	CHKD	Wilson	MATL:	Wilson	TOLERANCE	Mason	DATE	06.09.2010
APPD:	Schumi			FINISH	Jamy		Sheet No.	1 from 4	

EDCON-COMPONENTS

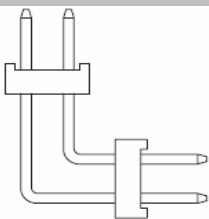

Pin Code length table free configuration

Order Code	Dimension (mm)			
	A	B	D1	D2
A01				
A02				
A03				
A04				
A05				
A06				
A07				
A08				
A09				
A10				
A11				
A12				
A13				
A14				
A15				
A16				
A17				
A18				
A19				
A20				
A21				
A22				

Order Code	Dimension (mm)			
	A	B	D1	D2
A23				
A24				
A25				
A26				
A27				
A28				
A29				
A30				
A31				
A32				
A33				
A34				
A35				
A36				
A37				
A38				
A39				
A40				
A41				
A42				
A43				
A44				

Order Code	Dimension (mm)			
	A	B	D1	D2
A45				
A46				
A47				
A48				
A49				
A50				
A51				
A52				
A53				
A54				
A55				
A56				
A57				
A58				
A59				
A60				
A61				
A62				
A63				
A64				
A65				
A66				

PIN Header / Dual Row / Dual Body / Pitch 2,00mm

Part No.: **T51B1038**

DRW:	Jason	CHKD	Wilson	MATL:	Wilson	TOLERANCE	Mason	DATE	06.09.2010
APPD:	Schumi			FINISH	Jamy		Sheet No.		2 from 4

Customer:

EDCON-COMPONENTS

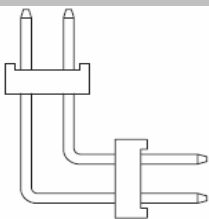

Ordering Informations

Serie	No. of Pos.	Construction	Contact Plating	Material	Plastic Function	Pin Length Code	ROHS	Packing		
T51B1038	XX	RT	G0	PB	1	A01	R	BU		

XX = total pin of header	RT = Right Angle THT	G0 = Gold Flash (Standard)	PB =P.B.T (Standard)	1 =Type 1	look table page 2	N =NO ROHS conform	BU = Bulk (Standard)
T0 = Tin plated	PA = Polyester 6T	GA = 10µ Gold Plating		2 =Type 2		R =ROHS conform	TU = Tube w/o Cap
GB = 15µ Gold Plating		GC = 20µ Gold Plating				TC = Tube w. pic and Place Cap	TY = Tray packing w/o Cap
S0 = Selectiv Plating Gold Flash / Tin						TR = Tape/Reel w. pic and Place Cap	
TN = Tin Plated							

PIN Header / Dual Row / Dual Body / Pitch 2,00mm	
Part No.:	T51B1038
Customer:	

DRW:	Jason	CHKD	Wilson	MATL:	Wilson	TOLERANCE	Mason	DATE	06.09.2010
APPD:	Schumi			FINISH	Jamy		Sheet No.		3 from 4

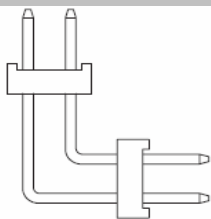

Soldering Profile for Lead Free Soldering

Classification Reflow Profile (JEDEC J-STD-020C)



PIN Header / Dual Row / Dual Body / Pitch 2,00mm
Part No.: T51B1038

DRW:	Jason	CHKD	Wilson	MATL:	Wilson	TOLERANCE	Mason	DATE	06.09.2010	Customer:
APPD:	Schumi			FINISH	Jamy		Sheet No.	4 from 4		