

EDCON-COMPONENTS

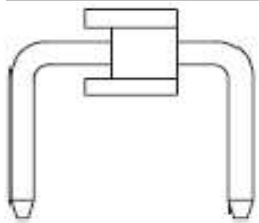

Specifications

| | |
|--------------------------|--|
| Current Rating: | 3,0 Ampere |
| Insulator Resistance: | 5000 Megaohm min. |
| Dielectric Withstanding: | AC 500V |
| Operating Temperature: | -.40°C to +105°C |
| Contact Material: | Copper, Alloy |
| Insulator Material: | P.B.T / PA6T |
| Standard: | PBT |
| Contact Plating: | Tin, Gold or Selective Plated |
| Standard: | Gold Flash Overall |
| Selectiv Plating: | Gold flash plated on contact area / tin plated on solder area |
| Max. Prozessing Temp. | 230°C for 60 seconds |

P.C.B Layout

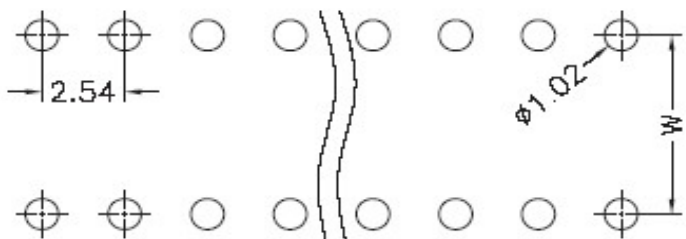

Drawing (dimensions all into mm)

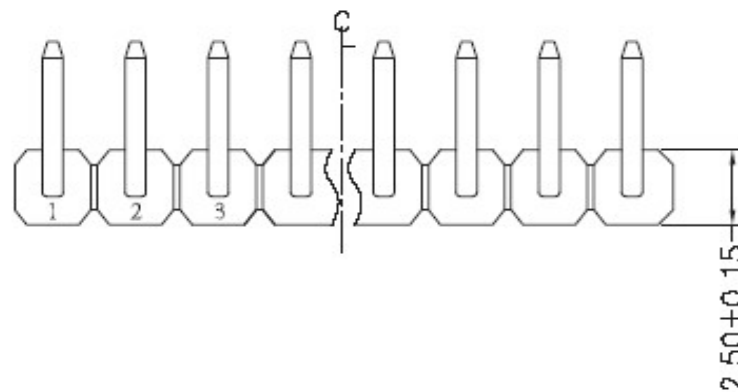
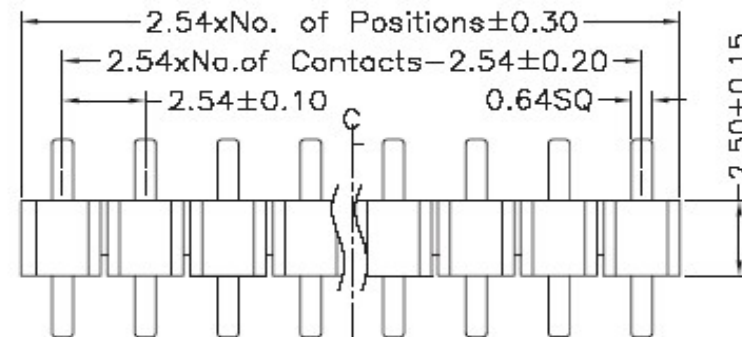
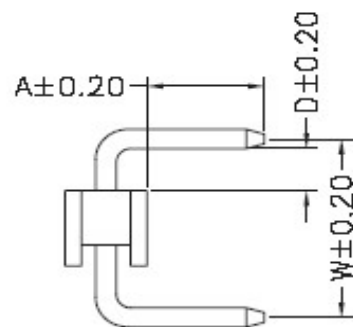

PIN Header / Single Row / Single Body / Pitch 2,54mm

Part No.: **T51A1047 -**

| | | | | | | | | | |
|-------|--------|------|--------|--------|--------|-----------|-----------|------|------------|
| DRW: | Jason | CHKD | Wilson | MATL: | Wilson | TOLERANCE | Mason | DATE | 14.05.2023 |
| APPD: | Schumi | | | FINISH | Jamy | | Sheet No. | | 1 from 4 |

Customer:

www.edcon-components.com

email: info@edcon-components.com

EDCON-COMPONENTS

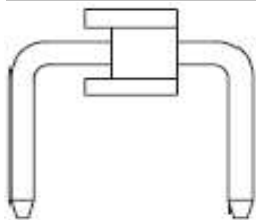

Pin Code length table free configuration

| Order Code | Dimension (mm) | | |
|------------|----------------|------|-------|
| | A | D | W |
| A01 | 6,00 | 2,75 | 8,68 |
| A02 | 6,00 | 2,75 | 7,50 |
| A03 | 6,00 | 2,75 | 7,62 |
| A04 | 6,00 | 2,75 | 8,00 |
| A05 | 6,00 | 2,75 | 8,50 |
| A06 | 6,00 | 2,75 | 5,00 |
| A07 | 6,00 | 2,75 | 5,08 |
| A08 | 6,00 | 2,75 | 6,35 |
| A09 | 6,00 | 2,75 | 10,00 |
| A10 | 6,00 | 2,75 | 12,50 |
| A11 | 6,00 | 2,75 | 15,00 |
| A12 | | | |
| A13 | | | |
| A14 | | | |
| A15 | | | |
| A16 | | | |
| A17 | | | |
| A18 | | | |
| A19 | | | |
| A20 | | | |
| A21 | | | |
| A22 | | | |
| A23 | | | |
| A24 | | | |
| A25 | | | |
| A26 | | | |
| A27 | | | |

| Order Code | Dimension (mm) | | |
|------------|----------------|---|---|
| | A | D | W |
| A28 | | | |
| A29 | | | |
| A30 | | | |
| A31 | | | |
| A32 | | | |
| A33 | | | |
| A34 | | | |
| A35 | | | |
| A36 | | | |
| A37 | | | |
| A38 | | | |
| A39 | | | |
| A40 | | | |
| A41 | | | |
| A42 | | | |
| A43 | | | |
| A44 | | | |
| A45 | | | |
| A46 | | | |
| A47 | | | |
| A48 | | | |
| A49 | | | |
| A50 | | | |
| A51 | | | |
| A52 | | | |
| A53 | | | |
| A54 | | | |

| Order Code | Dimension (mm) | | |
|------------|----------------|---|---|
| | A | D | W |
| A55 | | | |
| A56 | | | |
| A57 | | | |
| A58 | | | |
| A59 | | | |
| A60 | | | |
| A61 | | | |
| A62 | | | |
| A63 | | | |
| A64 | | | |
| A65 | | | |
| A66 | | | |
| A67 | | | |
| A68 | | | |
| A69 | | | |
| A70 | | | |
| A71 | | | |
| A72 | | | |
| A73 | | | |
| A74 | | | |
| A75 | | | |
| A76 | | | |
| A77 | | | |
| A78 | | | |
| A79 | | | |
| A80 | | | |
| A81 | | | |

| Order Code | Dimension (mm) | | |
|------------|----------------|---|---|
| | A | D | W |
| A82 | | | |
| A83 | | | |
| A84 | | | |
| A85 | | | |
| A86 | | | |
| A87 | | | |
| A88 | | | |
| A89 | | | |
| A90 | | | |
| A91 | | | |
| A92 | | | |
| A93 | | | |
| A94 | | | |
| A95 | | | |
| A96 | | | |
| A97 | | | |
| A98 | | | |
| A99 | | | |
| B00 | | | |
| B01 | | | |
| B02 | | | |
| B03 | | | |
| B04 | | | |
| B05 | | | |
| B06 | | | |
| B07 | | | |
| B08 | | | |

| Order Code | Dimension (mm) | | |
|------------|----------------|---|---|
| | A | D | W |
| B09 | | | |
| B10 | | | |
| B11 | | | |
| B12 | | | |
| B13 | | | |
| B14 | | | |
| B15 | | | |
| B16 | | | |
| B17 | | | |
| B18 | | | |
| B19 | | | |
| B20 | | | |
| B21 | | | |
| B22 | | | |
| B23 | | | |
| B24 | | | |
| B25 | | | |
| B26 | | | |
| B27 | | | |
| B28 | | | |
| B29 | | | |
| B30 | | | |
| B31 | | | |

PIN Header / Single Row / Single Body / Pitch 2,54mm

Part No.: **T51A1047 -**

Customer:

| | | | | | | | | | |
|-------|--------|------|--------|--------|--------|-----------|-----------|------|------------|
| DRW: | Jason | CHKD | Wilson | MATL: | Wilson | TOLERANCE | Mason | DATE | 14.05.2023 |
| APPD: | Schumi | | | FINISH | Jamy | | Sheet No. | | 2 from 4 |

EDCON-COMPONENTS

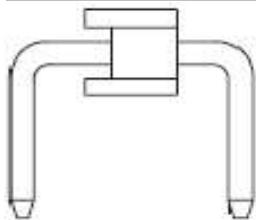

Ordering Informations

| Serie | No. of Pos. | Construction | Contact Plating | Material | Special Funtion | Pin Length Code | ROHS | Packing | | |
|-------|-------------|--------------|-----------------|----------|-----------------|-----------------|------|---------|--|--|
|-------|-------------|--------------|-----------------|----------|-----------------|-----------------|------|---------|--|--|

| | | | | | | | | | | |
|-------------------|-----------|-----------|-----------|-----------|----------|------------|----------|-----------|--|--|
| T51A1047 - | XX | RT | G0 | PB | X | A01 | R | BU | | |
|-------------------|-----------|-----------|-----------|-----------|----------|------------|----------|-----------|--|--|

| | | | | | | | |
|---------------------------------|-----------------------------|---|-----------------------------|------------------------|-------------------|---------------------------|--|
| XX = total pin of header | RT = Right angle THT | G0 = Gold Flash (Standard) | PB =P.B.T (Standard) | X = No function | look table page 2 | N =NO ROHS conform | BU = Bulk (Standard) |
| | | T0 = Tin plated | PA = Polyester 6T | | | R =ROHS conform | TU = Tube w/o Cap |
| | | GA = 10µ Gold Plating | | | | | TC = Tube w. pic and Place Cap |
| | | GB = 15µ Gold Plating | | | | | TY = Tray packing w/o Cap |
| | | GC = 20µ Gold Plating | | | | | TR = Tape/Reel w. pic and Place Cap |
| | | S0 = Selectiv Plating Gold Flash / Tin | | | | | |
| | | TN = Tin Plated | | | | | |

| |
|--|
| PIN Header / Single Row / Single Body / Pitch 2,54mm |
| Part No.: T51A1047 - |
| Customer: |

| | | | | | | | | | |
|-------|--------|------|--------|--------|--------|-----------|-----------|------|------------|
| DRW: | Jason | CHKD | Wilson | MATL: | Wilson | TOLERANCE | Mason | DATE | 14.05.2023 |
| APPD: | Schumi | | | FINISH | Jamy | | Sheet No. | | 3 from 4 |

www.edcon-components.com

email: info@edcon-components.com

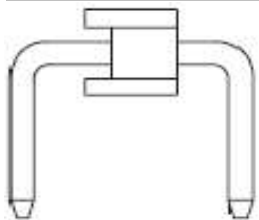

Soldering Profile for Lead Free Soldering

Classification Reflow Profile (JEDEC J-STD-020C)

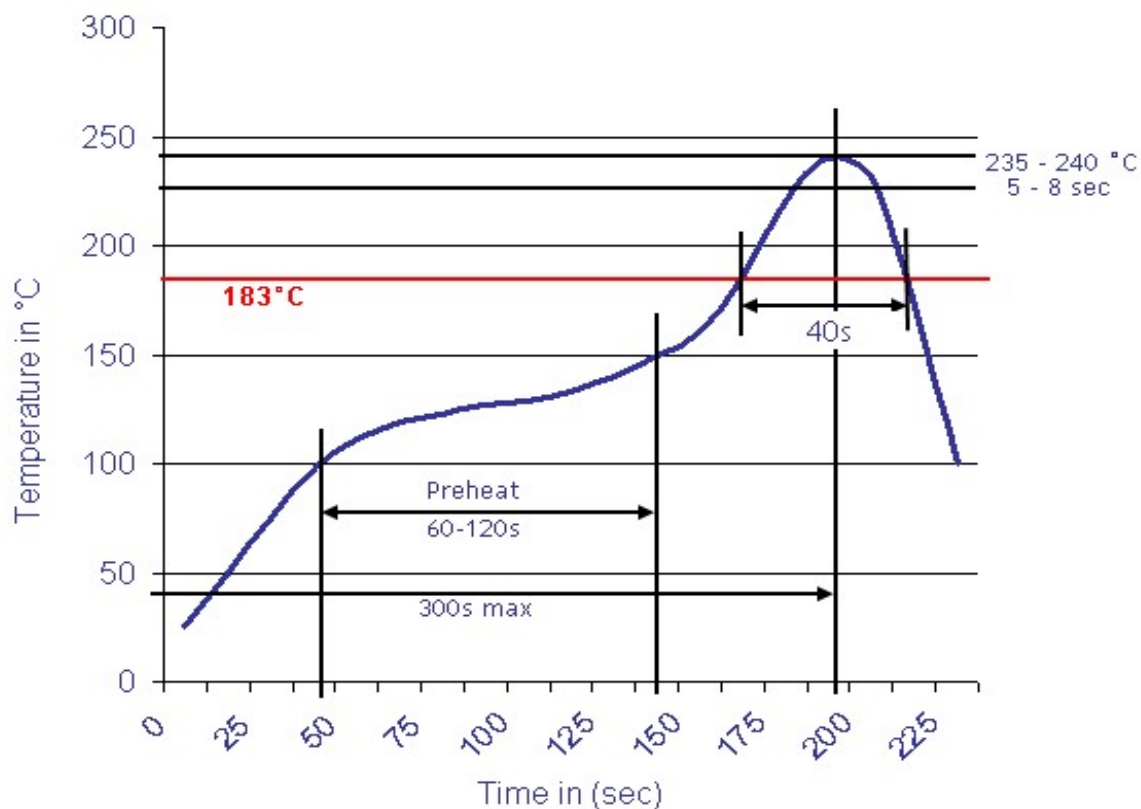

PIN Header / Single Row / Single
Body / Pitch 2,54mm

Part No.: **T51A1047 -**

| | | | | | | | | | |
|-------|--------|------|--------|--------|--------|-----------|-----------|----------|------------|
| DRW: | Jason | CHKD | Wilson | MATL: | Wilson | TOLERANCE | Mason | DATE | 14.05.2023 |
| APPD: | Schumi | | | FINISH | Jamy | | Sheet No. | 4 from 4 | Customer: |