

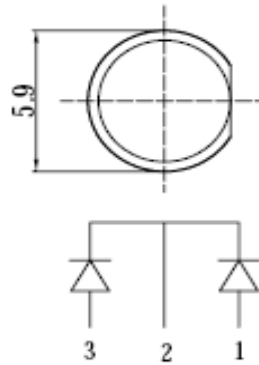

Applications

- Electronic Signs and Signals
- Small Area Illuminations
 - Back Lighting
 - Other Lighting

Technical Drawing

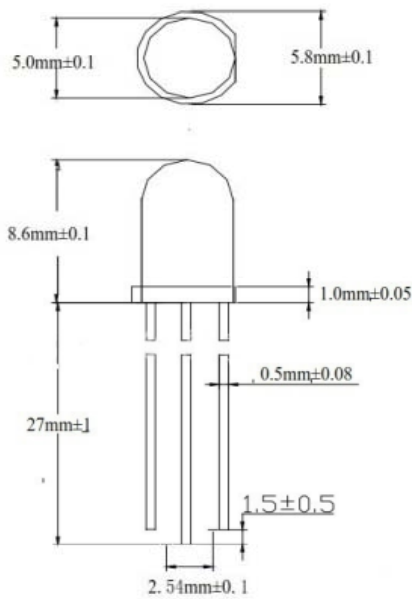

2. Common Cathode
1, 3. Anode

Notes :

All dimensions in mm tolerance is ± 0.1 mm unless otherwise noted.

Round LED	
Red	Yellow Green
Part No.:	M13J1007
Customer:	

DRW:	Ron	CHKD	Lang	MATL:	Chang	DATE	29.11.2018
APPD:	Xie			FINISH	Wang	Sheet	1 from 6



Absolute Maximum Ratings

Item	Symbol	---	---	Unit
Power Dissipation	P _D	78	78	mW
DC Forward Current	I _F	30	30	mA
Plused Forward Current	I _{FP} *	100	100	mA
Reverse Voltage	V _R	5		V
Operating Temperature	T _{OP}	-30 to 85		°C
Storage Temperature	T _{ST}	-40 to 100		°C

* 0.1 msec pulse, 10% duty cycle

Electrcal / Optical Characteristics

Ermitting Color Material	Red		Yellow Green	
	---	---	---	---
Forward Voltage	typ.	2.1	2.1	V _F
	max.	2.6	2.6	V _F
Wavelength typ.	λD	620	565	nm
	λP	625	570	nm
	Δλ	---	---	nm
Color Temperature	min.	---	---	K
	max.	---	---	K
Luminous Intensity *	min.	500	330	mcd
	typ.	750	550	mcd
Reverse Current	max.	10		μA
Viewing Angle	2Θ1/2	60		

* Per NIST standards

Round LED	
Red	Yellow Green
Part No.:	M13J1007
Customer:	

DRW:	Ron	CHKD	Lang	MATL:	Chang	DATE	29.11.2018
APPD:	Xie			FINISH	Wang	Sheet	2 from 6



Round LED	
Red	Yellow Green
Part No.:	M13J1007
Customer:	

DRW:	Ron	CHKD	Lang	MATL:	Chang	DATE	29.11.2018
APPD:	Xie			FINISH	Wang	Sheet	3 from 6



Typical Characteristics

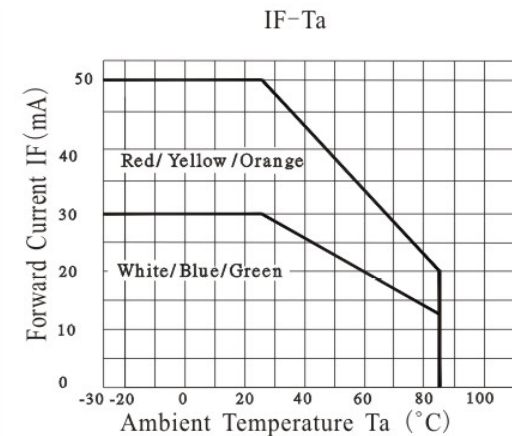
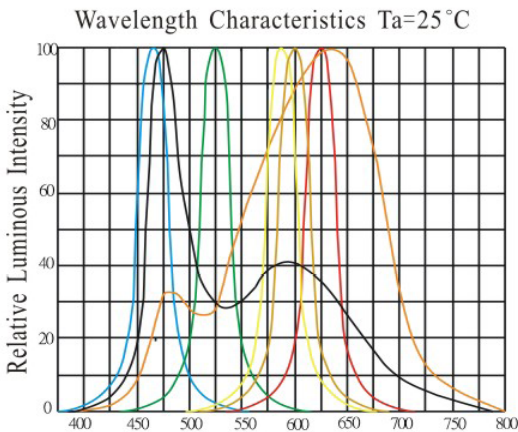
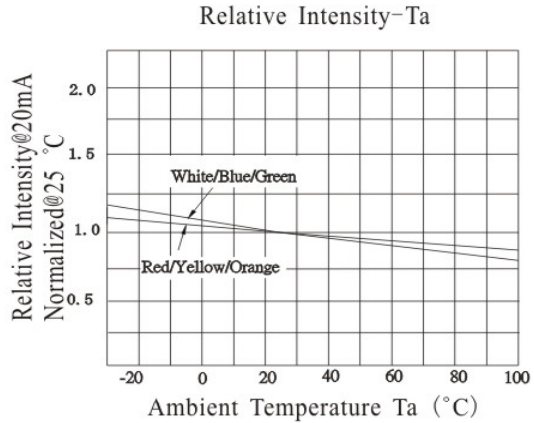
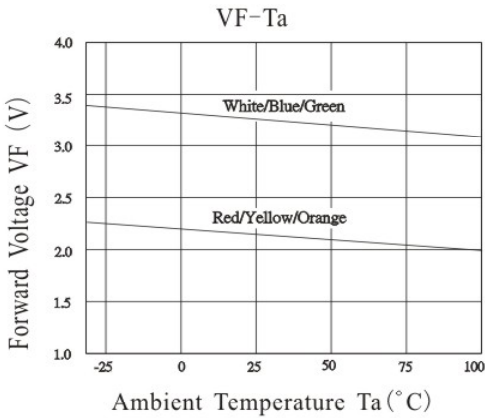
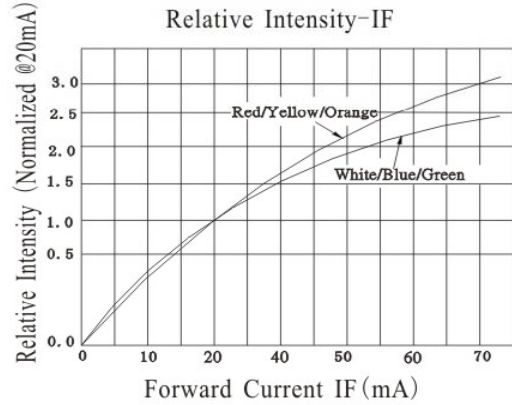
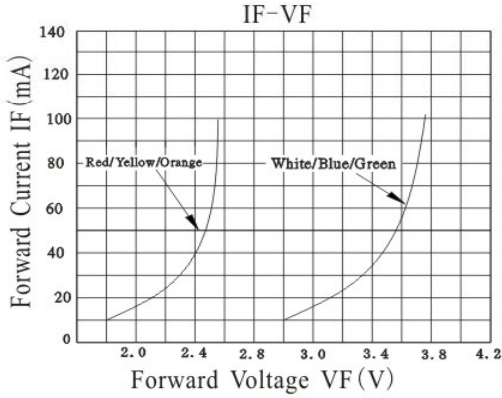

Round LED	
Red	Yellow Green
Part No.:	M13J1007
Customer:	

DRW:	Ron	CHKD	Lang	MATL:	Chang	DATE	29.11.2018
APPD:	Xie			FINISH	Wang	Sheet	4 from 6



Solder Condition

Lead Free Solder

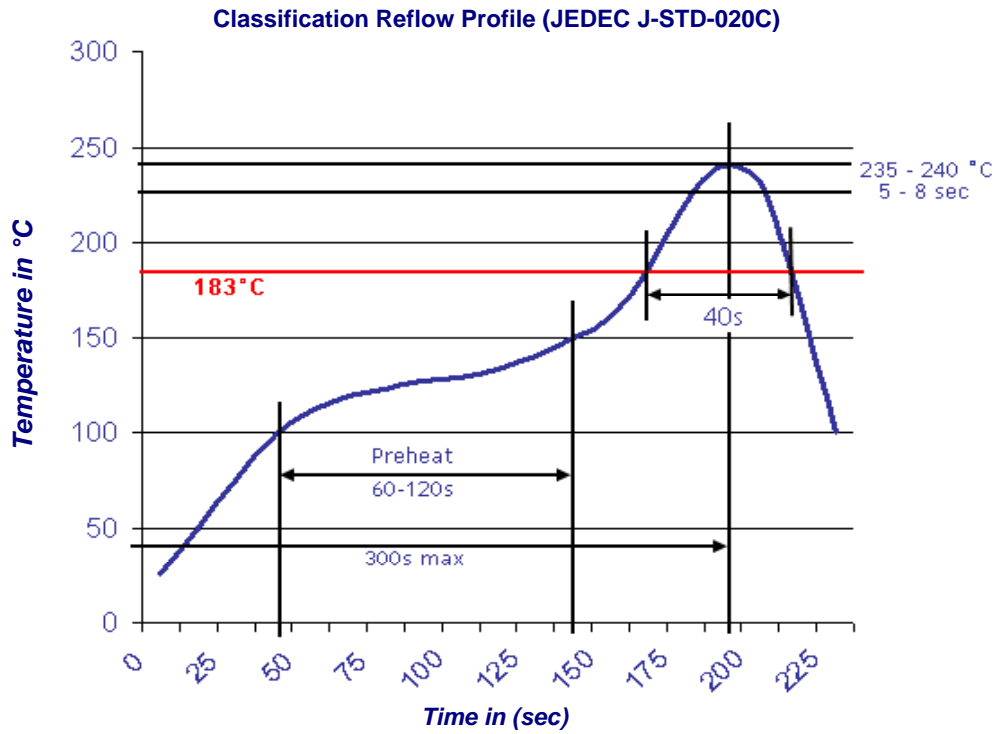

Round LED	
Red	Yellow Green
Part No.:	M13J1007
Customer:	

DRW:	Ron	CHKD	Lang	MATL:	Chang	DATE	29.11.2018
APPD:	Xie			FINISH	Wang	Sheet	5 from 6



Color table curve

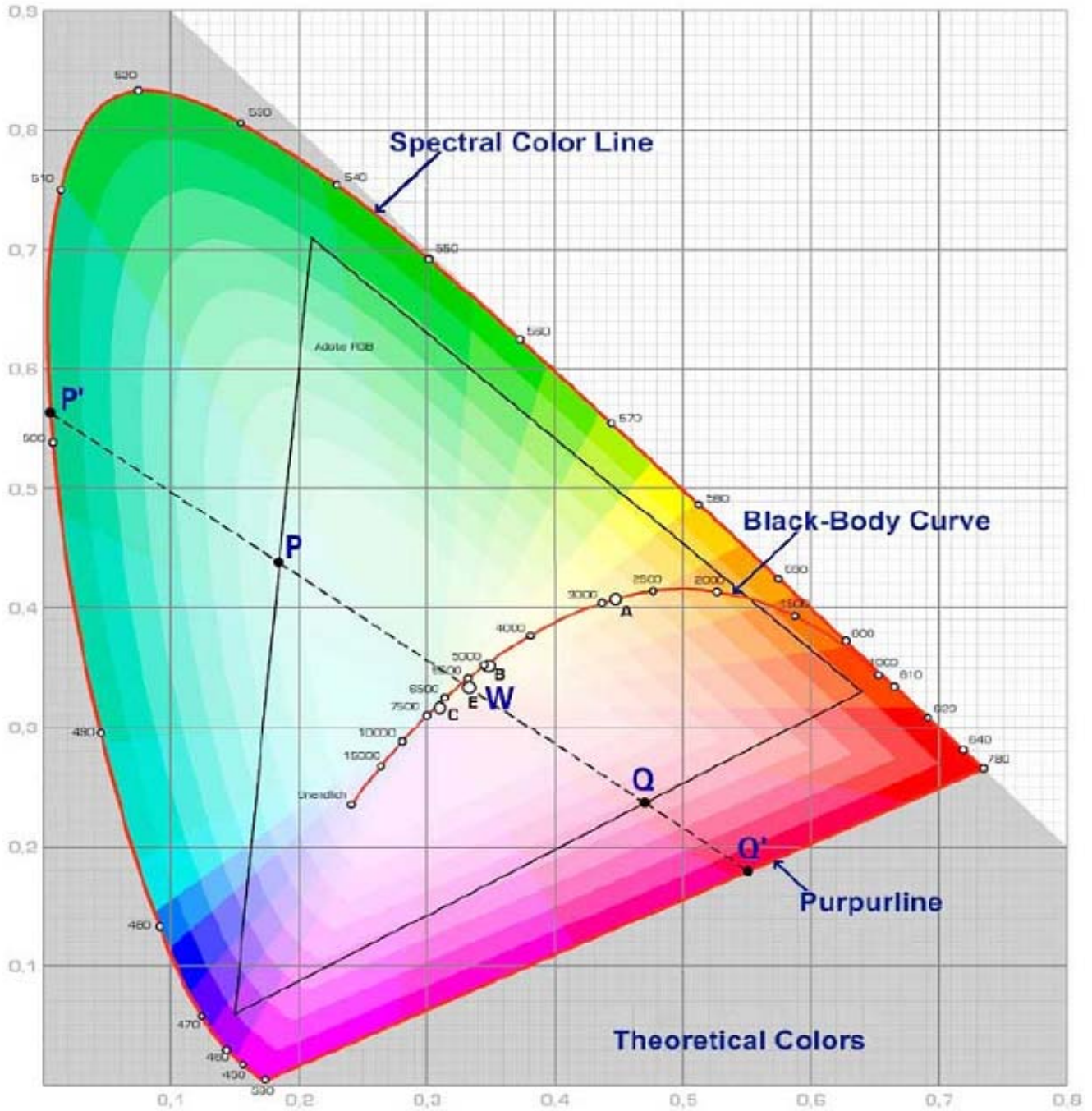

Round LED	
Red	Yellow Green
Part No.:	M13J1007
Customer:	

DRW:	Ron	CHKD	Lang	MATL:	Chang	DATE	29.11.2018
APPD:	Xie			FINISH	Wang	Sheet	6 from 6