

Data Sheet

Pluggable Terminal Block (Header)

Pitch: 3,81 mm

Serie: A14H145

Customer Information for special Item

EDCON Customer : 0

Customer Version No. : 0

EDCON-COMPONENTS

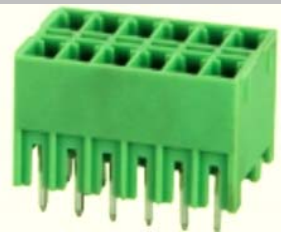

Technical Discription

Drawing (Dimension in mm)

| | | |
|-----------------------|-------------------|-----|
| Electrical | UL | IEC |
| Rated Voltage | 300Volt | |
| Rated Current | 8A | |
| | | |
| Withstanding Voltage | AC 2000V / 1 Min. | |
| Insulation Resistance | | |
| Mechanical | | |
| Operating Temperature | . -40°C ~ +105°C | |
| | | |
| Dimensions | | |
| Pitch (mm) | 3,81 | |
| Poles | 04 ~ 48 Pos. | |
| Materials | | |
| Terminal Housing | PA66, UL94V-0 | |
| | | |
| Pin Header | Brass Tin Plated | |

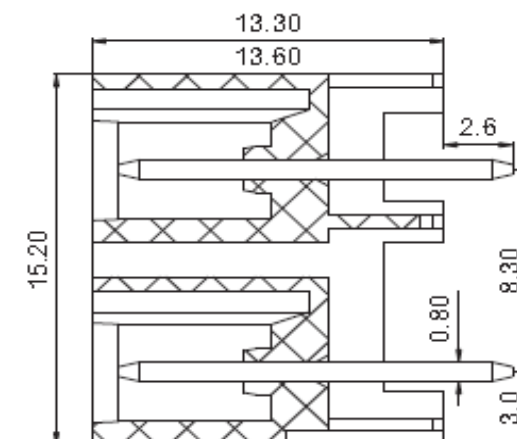
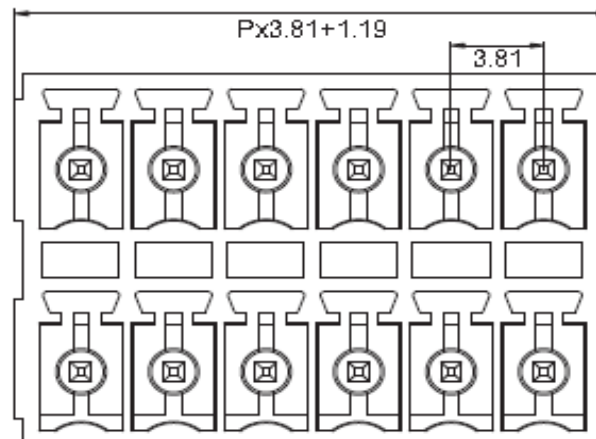

| | |
|--|----------------|
| Pluggable Terminal Block (Header) | |
| Part No.: | A14H145 |
| Customer: | |

| | | | | | | | | | |
|-------|--------|------|--------|--------|--------|-----------|-----------|----------|------------|
| DRW: | Jason | CHKD | Wilson | MATL: | Wilson | TOLERANCE | Mason | DATE | 25.03.2017 |
| APPD: | Schumi | | | FINISH | Jamy | | Sheet No. | 1 from 4 | |

EDCON-COMPONENTS

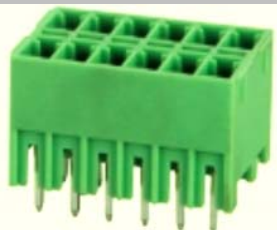

PCB Layout

Dimensions (mm)

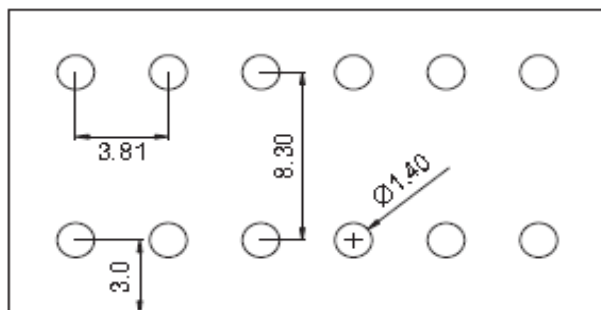

| No. of Pos. | P | Tol. A | B | Tol. B |
|-------------|-------|--------|-------|--------|
| 02 | 5,00 | ± 0,15 | 3,81 | ± 0,15 |
| 03 | 8,81 | ± 0,15 | 7,62 | ± 0,15 |
| 04 | 12,62 | ± 0,15 | 11,43 | ± 0,15 |
| 05 | 16,43 | ± 0,15 | 15,24 | ± 0,15 |
| 06 | 20,24 | ± 0,15 | 19,05 | ± 0,15 |
| 07 | 24,05 | ± 0,20 | 22,86 | ± 0,20 |
| 08 | 27,86 | ± 0,20 | 26,67 | ± 0,20 |
| 09 | 31,67 | ± 0,20 | 30,48 | ± 0,20 |
| 10 | 35,48 | ± 0,20 | 34,29 | ± 0,20 |
| 11 | 39,29 | ± 0,20 | 38,10 | ± 0,20 |
| 12 | 43,10 | ± 0,20 | 41,91 | ± 0,20 |
| 13 | 46,91 | ± 0,25 | 45,72 | ± 0,25 |
| 14 | 50,72 | ± 0,25 | 49,53 | ± 0,25 |
| 15 | 54,53 | ± 0,25 | 53,34 | ± 0,25 |
| 16 | 58,34 | ± 0,25 | 57,15 | ± 0,25 |
| 17 | 62,15 | ± 0,25 | 60,96 | ± 0,25 |
| 18 | 65,96 | ± 0,25 | 64,77 | ± 0,25 |
| 19 | 69,77 | ± 0,30 | 68,58 | ± 0,30 |
| 20 | 73,58 | ± 0,30 | 72,39 | ± 0,30 |
| 21 | 77,39 | ± 0,30 | 76,20 | ± 0,30 |
| 22 | 81,20 | ± 0,30 | 80,01 | ± 0,30 |
| 23 | 85,01 | ± 0,30 | 83,82 | ± 0,30 |
| 24 | 88,82 | ± 0,30 | 87,63 | ± 0,30 |

Pluggable Terminal Block (Header)

Part No.: **A14H145**

Customer:

| | | | | | | | | | |
|-------|--------|------|--------|--------|--------|-----------|-----------|------|------------|
| DRW: | Jason | CHKD | Wilson | MATL: | Wilson | TOLERANCE | Mason | DATE | 25.03.2017 |
| APPD: | Schumi | | | FINISH | Jamy | | Sheet No. | | 2 from 4 |

EDCON-COMPONENTS

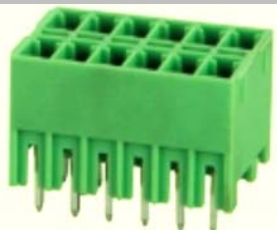

Ordering Informations

| Serie | No. of Pos. | Body Color | No Function | Approval Code | ROHS | Packing | EDCON Cust. No. | Customer Version | | |
|-------|-------------|------------|-------------|---------------|------|---------|-----------------|------------------|--|--|
|-------|-------------|------------|-------------|---------------|------|---------|-----------------|------------------|--|--|

| | | | | | | | | | | |
|----------------|-----------|-----------|----------|----------|----------|----------|--|--|--|--|
| A14H145 | 04 | PG | N | N | R | B | | | | |
|----------------|-----------|-----------|----------|----------|----------|----------|--|--|--|--|

| | | | | | | | | | | |
|---------------|--|---|------------------------|--|--|---|---------------------------------|--|--|--|
| Pitch 3,81 | 04 = Number of Pos. 04 to 48 Pos. Standard | PG = Phoenix Green (Standard) WH = White GN = Green GY = Gray LG = Light Gray OR = Orange BL = Blue BK = Black | N = No function | N = NON Approval A = UL /UR Approval Please consult EDCON for available B = VDE Approval Please consult EDCON for available C = TÜV Approval Please consult EDCON for available | R = ROHS Conform N = NON ROHS Conform | B = Bulk-Ware I = Individual Package | xxxxxx = Customer Number | xxx = Customer Version ??(Printing) | | |
|---------------|--|---|------------------------|--|--|---|---------------------------------|--|--|--|

Pluggable Terminal Block (Header)

Part No.: **A14H145**

| | | | | | | | | | |
|-------|--------|------|--------|--------|--------|-----------|-----------|------|------------|
| DRW: | Jason | CHKD | Wilson | MATL: | Wilson | TOLERANCE | Mason | DATE | 25.03.2017 |
| APPD: | Schumi | | | FINISH | Jamy | | Sheet No. | | 3 from 4 |

Customer:

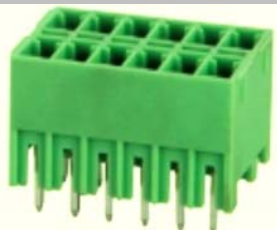

Soldering Profile Curve

Classification Reflow Profile (JEDEC J-STD-020C)

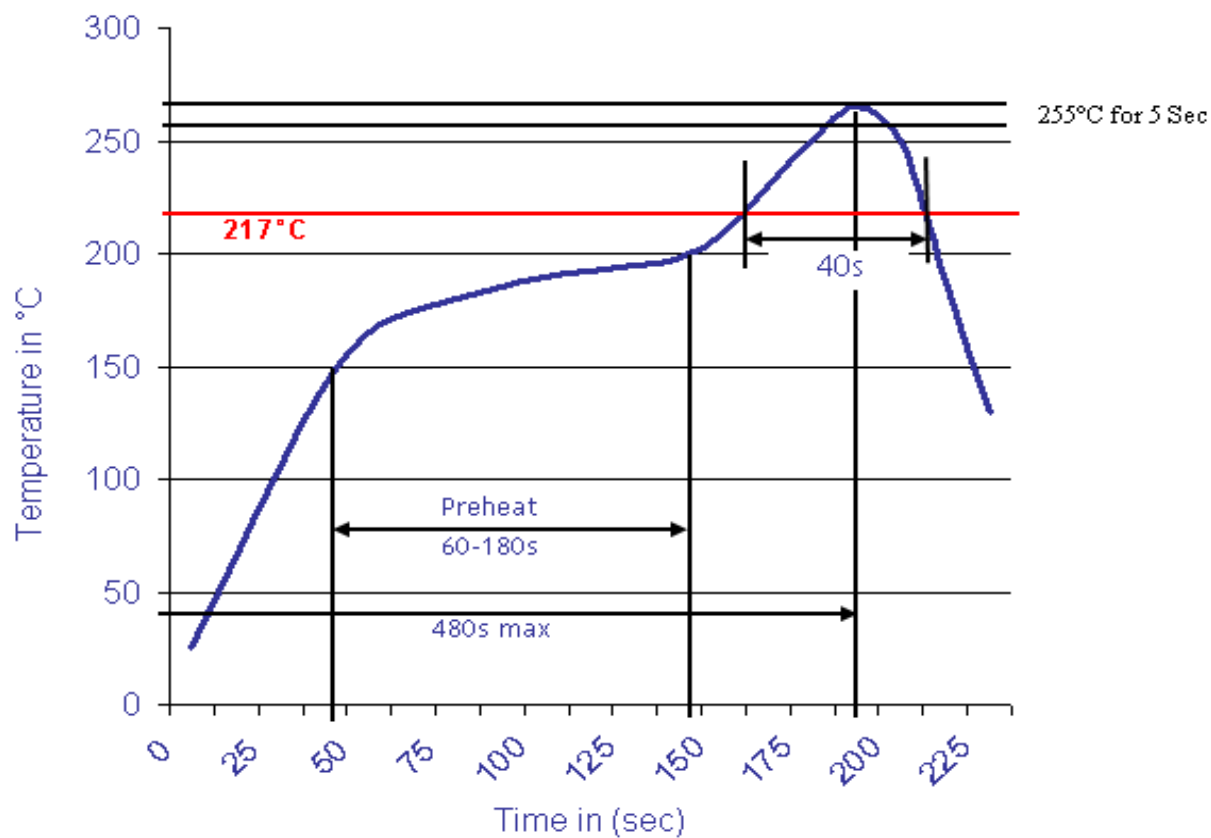

**Pluggable Terminal Block
(Header)**

Part No.: **A14H145**

Customer:

| | | | | | | | | | |
|-------|--------|------|--------|--------|--------|-----------|-----------|----------|------------|
| DRW: | Jason | CHKD | Wilson | MATL: | Wilson | TOLERANCE | Mason | DATE | 25.03.2017 |
| APPD: | Schumi | | | FINISH | Jamy | | Sheet No. | 4 from 4 | |