

# EDCON-COMPONENTS

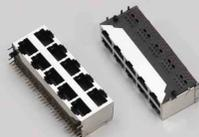

## Technical Discription

### Electrical

Current Rating: 1,5A  
 Voltage Rating: 125VAC  
 Insulation Resistance: 500M  $\Omega$  min.  
 Contact Resistance: 30M  $\Omega$  max.  
 Withstanding Voltage: AC1000V RMS 50/60Hz 1min.

### Mechanical

Insertion Force: 2,2Kg.F.max.  
 Retention Strength: 7,7Kg.F min.between jack a. plug  
 Durability: 600 mating cycles min.

### Material

Housing: ABS RESIN (UL94V-0)  
 PBT(UL94V-0 PA66(UÖ94V-0)  
 PA46(UL94V-0)  
 Diameter 0,45mm Phosphor  
 Bronze Gold Plating over Nickel  
 Contact wire: 0,35mm thickness phosphor  
 bronze alloy selective Gold plating  
 over nickel  
 Shield 0,20~0,25mm thickness brass with  
 tin plated  
 Contact Plating Gold Flash, 3 $\mu$  / 6 $\mu$  / 15 $\mu$  / 30 $\mu$  50 $\mu$   
 inch

Working Temperatur . -40°C ~ +70°C

## Technical Drawing

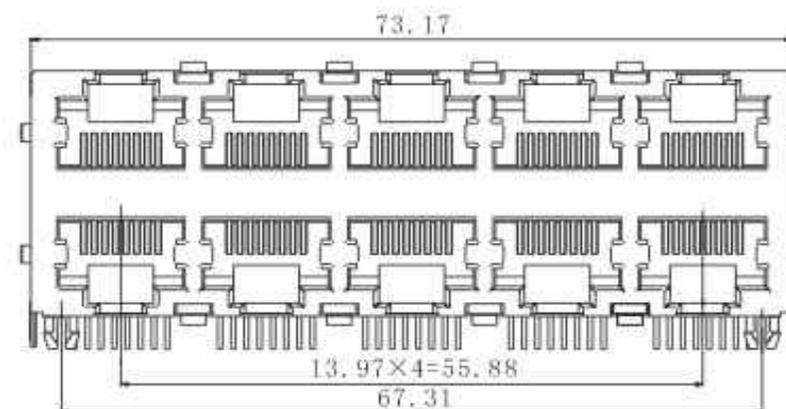
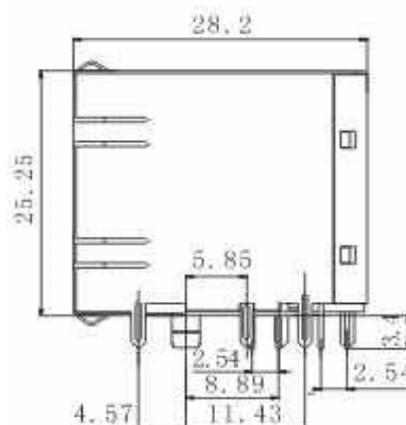

## PCB Layout

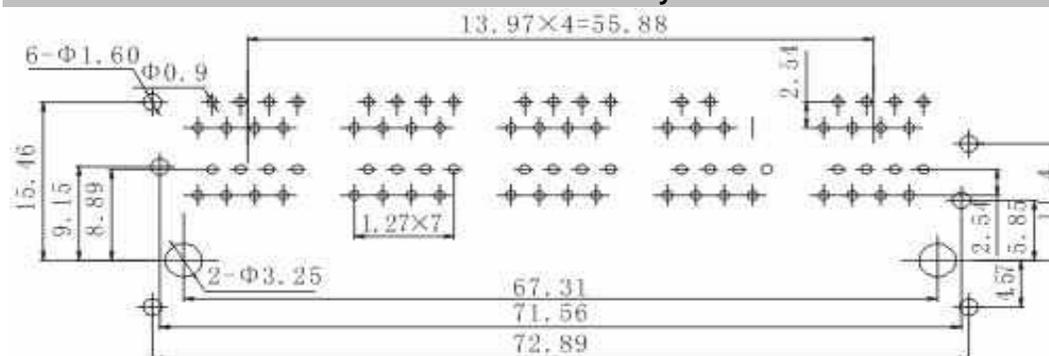

**PCB Modular Jack w.  
shield w/o. flange**

Part No.: **T91A24014**

Customer:

DRW:	John	CHKD	Tony	MATL:	Tony	TOLERANCE	Su	DATE	10.04.2009
APPD:	Jimmy			FINISH	Jeff		Sheet No.		1 from 3

[www.edcon-components.com](http://www.edcon-components.com)

email: [info@edcon-components.com](mailto:info@edcon-components.com)

# EDCON-COMPONENTS

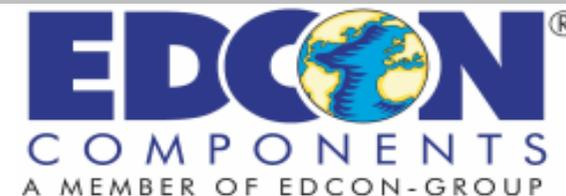
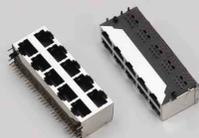

## Ordering Informations

Serie	No. Of. Positions	No. Of Contact	Contact Plating	ROHS	Packing					
<b>T91A24014</b>	<b>8</b>	<b>8</b>	<b>GF</b>	<b>R</b>	<b>TY</b>					

<b>8=</b> 8Pos.	<b>8=</b> 8Pos. connecting	<b>GF=</b> Gold Flash	<b>R=</b> ROHS conform	<b>TY=</b> Tray Packing
		<b>GA=</b> 3 $\mu$ Gold Plating	<b>N=</b> NON ROHS conform	<b>BU=</b> Bulk-Ware
		<b>GB=</b> 6 $\mu$ Gold Plating		
		<b>GC=</b> 15 $\mu$ Gold Plating		
		<b>GD=</b> 30 $\mu$ Gold Plating		
		<b>GE=</b> 50 $\mu$ Gold Plating		

<b>PCB Modular Jack w. shield w/o. flange</b>	
Part No.:	<b>T91A24014</b>
Customer:	

DRW:	John	CHKD	Tony	MATL:	Tony	TOLERANCE	Su	DATE	10.04.2009
APPD:	Jimmy			FINISH	Jeff		Sheet No.		2 from 3

[www.edcon-components.com](http://www.edcon-components.com)

email: [info@edcon-components.com](mailto:info@edcon-components.com)

Copyright by EDCON-COMPONENTS H.Schmitt

**EDCON-COMPONENTS**



**Soldering Profile Curve**

**Lead Free Soldering Curve**

**Classification Reflow Profile (JEDEC J-STD-020C)**

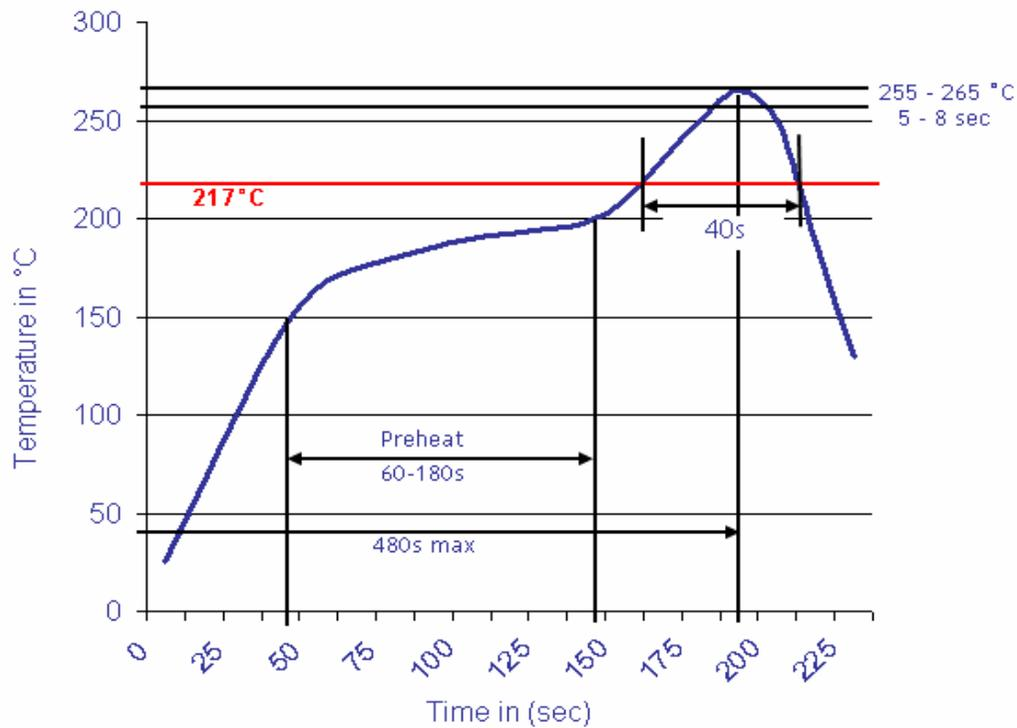

**PCB Modular Jack w.  
 shield w/o. flange**

Part No.: **T91A24014**

DRW:	John	CHKD	Tony	MATL:	Tony	TOLERANCE	Su	DATE	10.04.2009
APPD:	Jimmy			FINISH	Jeff		Sheet No.	3 from 3	Customer: