

EDCON-COMPONENTS

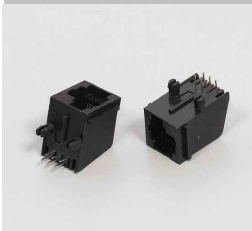

Technical Discription

Electrical

Current Rating: 1,5A
 Voltage Rating: 125VAC
 Insulation Resistance: 500M Ω min.
 Contact Resistance: 30M Ω max.
 Withstanding Voltage: AC1000V RMS 50/60Hz 1min.

Mechanical

Insertion Force: 2,2Kg.F.max.
 Retention Strength: 7,7Kg.F min.beetween jack a. plug
 Durability: 600 mating cycles min.

Material

Housing: ABS RESIN (UL94V-0)
 PBT(UL94V-0 PA66(UÖ94V-0)
 PA46(UL94V-0)
 Diameter 0,45mm Phosphor
 Bronze Gold Plating over Nickel
 Contact wire: 0,35mm thickness phosphor
 bronze alloy selective Gold plating
 over nickel
 Shield 0,20~0,25mm thickness brass with
 tin plated
 Contact Plating Gold Flash, 3 μ / 6 μ / 15 μ / 30 μ 50 μ
 inch
 Working Temperatur . -40°C ~ +70°C

Technical Drawing

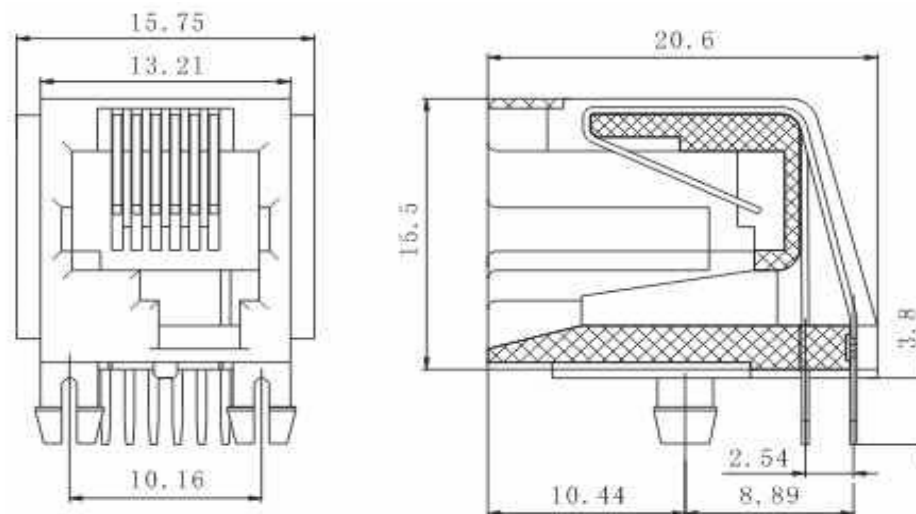

PCB Layout

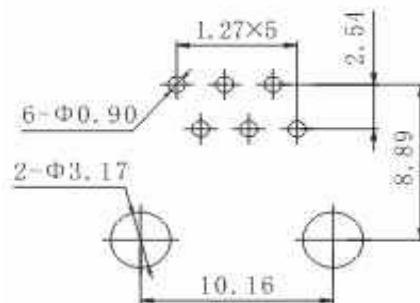

**PCB Modular Jack w/o
 shield with flange**

T91A11044

DRW:	John	CHKD	Tony	MATL:	Tony	TOLERANCE	Su	DATE	10.04.2009	Customer:
APPD:	Jimmy			FINISH	Jeff		Sheet No.	1 from 3		

www.edcon-components.com

email: info@edcon-components.com

EDCON-COMPONENTS



Ordering Informations

Serie	No. Of. Positions	No. Of Contact	Contact Plating	Housing Material	ROHS	Packing				
T91A11044	6	6	GF	PB	R	TY				

6= 6Pos.	6= 6Pos. connecting	GF= Gold Flash	PB= PBT	R= ROHS conform	TY= Tray Packing
		GA= 3μGold Plating	P4= PA46	N= NON ROHS conform	BU= Bulk-Ware
		GB= 6μGold Plating	P6= PA66		
		GC= 15μGold Plating	AB= ABS		
		GD= 30μGold Plating			
		GE= 50μGold Plating			

PCB Modular Jack w/o shield with flange

Part No.: **T91A11044**

DRW:	John	CHKD	Tony	MATL:	Tony	TOLERANCE	Su	DATE	10.04.2009
APPD:	Jimmy			FINISH	Jeff		Sheet No.		2 from 3

Customer:
email: info@edcon-components.com

www.edcon-components.com

Copyright by EDCON-COMPONENTS H.Schmitt

EDCON-COMPONENTS



Soldering Profile Curve

Lead Free Soldering Curve

Classification Reflow Profile (JEDEC J-STD-020C)

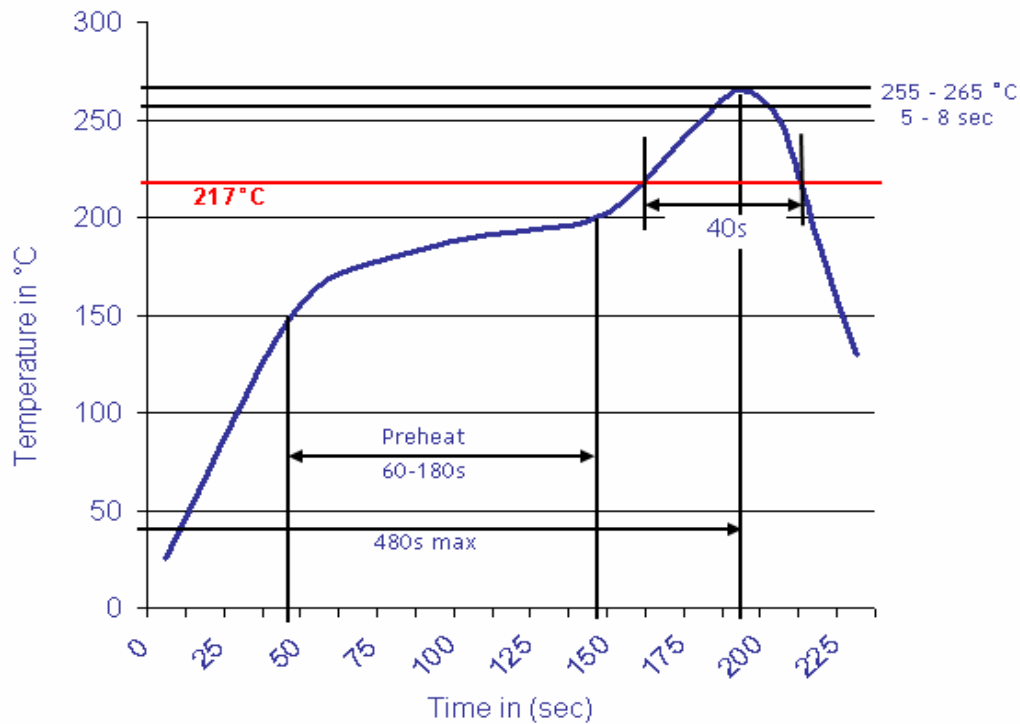

PCB Modular Jack w/o shield with flange

Part No.: **T91A11044**

DRW:	John	CHKD	Tony	MATL:	Tony	TOLERANCE	Su	DATE	10.04.2009
APPD:	Jimmy			FINISH	Jeff		Sheet No.	3 from 3	

Customer: