

EDCON-COMPONENTS

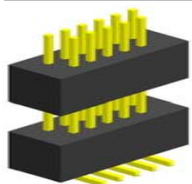

Specifications

| | |
|--------------------------|--|
| Current Rating: | 1,0 Ampere |
| Insulator Resistance: | 5000 Megaohm min. |
| Dielectric Withstanding: | AC 500V |
| Operating Temperature: | .-65°C to +125°C |
| Contact Material: | Brass |
| Insulator Material: | P.B.T. UL94V-0 |
| Standard: | P.B.T. |
| Contact Plating: | Tin, Gold or Selective Plated |
| Standard: | Gold Flash Overall |
| Selectiv Plating: | Gold flash plated on contact area / tin plated on solder area |

Drawing (dimensions all into mm)

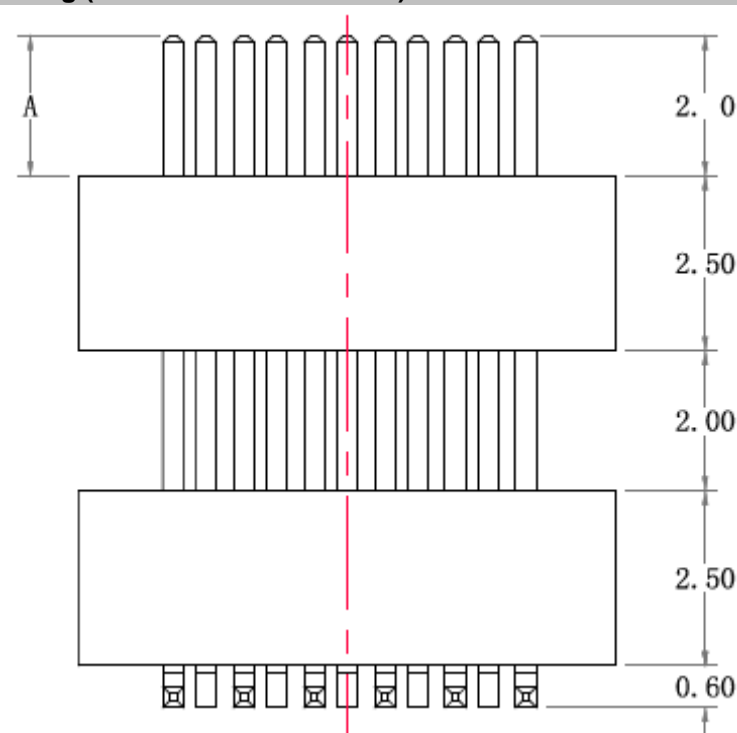
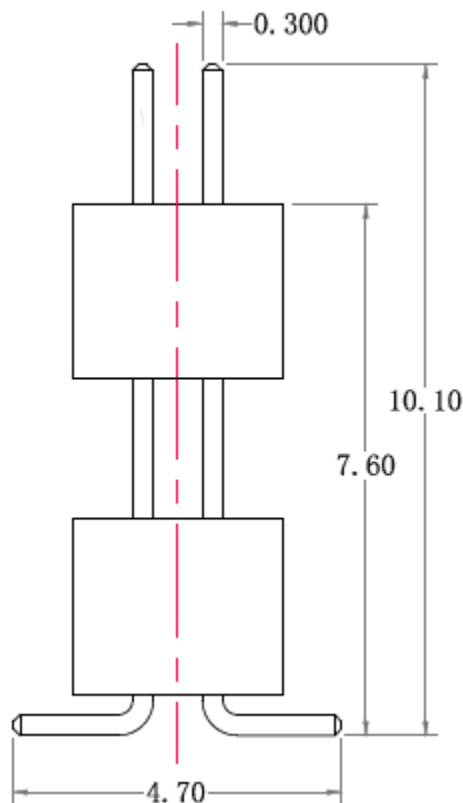
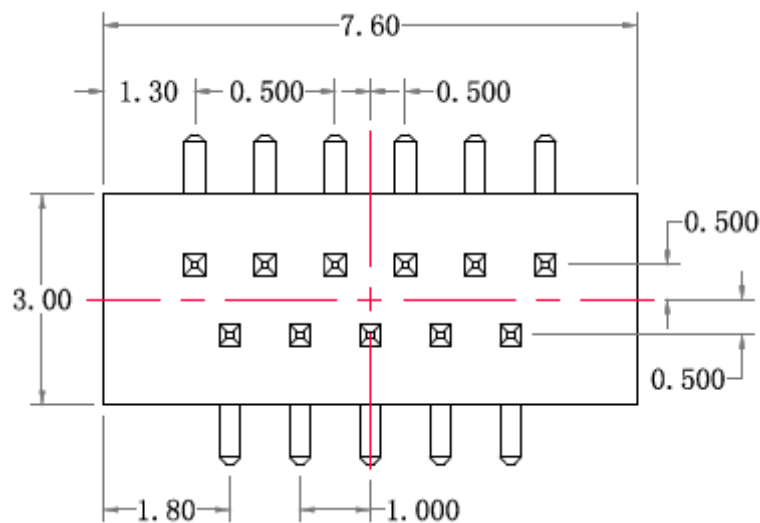

**THT PIN Header / Pitch
1,0x1,0mm**

Part No.: **T51D1020-**

Customer:

| | | | | | | | | | |
|-------|--------|------|--------|--------|--------|-----------|-----------|----------|------------|
| DRW: | Jason | CHKD | Wilson | MATL: | Wilson | TOLERANCE | Mason | DATE | 30.04.2017 |
| APPD: | Schumi | | | FINISH | Jamy | | Sheet No. | 1 from 4 | |

EDCON-COMPONENTS

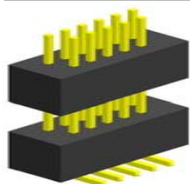

Pin Code length table free configuration

| Order Code | Dimension (mm) | | | |
|------------|----------------|--|--|--|
| | A | | | |
| A01 | 2,00 | | | |
| A02 | 2,50 | | | |
| A03 | 3,00 | | | |
| A04 | 3,50 | | | |
| A05 | 4,00 | | | |
| A06 | | | | |
| A07 | | | | |
| A08 | | | | |
| A09 | | | | |
| A10 | | | | |
| A11 | | | | |
| A12 | | | | |
| A13 | | | | |
| A14 | | | | |
| A15 | | | | |
| A16 | | | | |
| A17 | | | | |
| A18 | | | | |
| A19 | | | | |
| A20 | | | | |
| A21 | | | | |
| A22 | | | | |

| Order Code | Dimension (mm) | | | |
|------------|----------------|--|--|--|
| | A | | | |
| A23 | | | | |
| A24 | | | | |
| A25 | | | | |
| A26 | | | | |
| A27 | | | | |
| A28 | | | | |
| A29 | | | | |
| A30 | | | | |
| A31 | | | | |
| A32 | | | | |
| A33 | | | | |
| A34 | | | | |
| A35 | | | | |
| A36 | | | | |
| A37 | | | | |
| A38 | | | | |
| A39 | | | | |
| A40 | | | | |
| A41 | | | | |
| A42 | | | | |
| A43 | | | | |
| A44 | | | | |

**THT PIN Header / Pitch
1,0x1,0mm**

Part No.: **T51D1020-**

| | | | | | | | | | |
|-------|--------|------|--------|--------|--------|-----------|-----------|------|------------|
| DRW: | Jason | CHKD | Wilson | MATL: | Wilson | TOLERANCE | Mason | DATE | 30.04.2017 |
| APPD: | Schumi | | | FINISH | Jamy | | Sheet No. | | 2 from 4 |

Customer:

EDCON-COMPONENTS

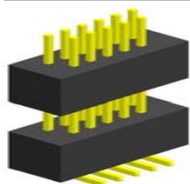

Ordering Informations

| Serie | No. of Pos. | Construction | Contact Plating | Body Material | Special Function | Pin Length Code | ROHS | Packing | | |
|------------------|-------------|--------------|-----------------|---------------|------------------|-----------------|----------|-----------|--|--|
| T51D1020- | 11 | SS | G0 | PB | N | A01 | R | TU | | |

| | | | | | | | |
|---------------|--------------------------|---|-----------------------------|-----------------------|-------------------|----------------------------------|--|
| 11Pos. | | G0 = Gold Flash (Standard) | PB =P.B.T (Standard) | N = No special | look table page 2 | N =NO ROHS conform | BU = Bulk (Standard) |
| | SS = Straight SMT | T0 = Tin plated | | | | R =ROHS conform | TU = Tube w/o Cap |
| | | GA = 3µ Gold Plating | NY = Nylon-PA6T | | | | TC = Tube w. pic and Place Cap |
| | | GB = 5µ Gold Plating | | | | TY = Tray packing w/o Cap | |
| | | GC = 10µ Gold Plating | | | | LC = LCP | TR = Tape/Reel w. pic and Place Cap |
| | | GD = 15µ Gold Plating | | | | | |
| | | GE = 20µ Gold Plating | | | | | |
| | | GF = 30µ Gold Plating | | | | | |
| | | S0 = Selectiv Plating Gold Flash / Tin | | | | | |

| | |
|---|------------------|
| THT PIN Header / Pitch 1,0x1,0mm | |
| Part No.: | T51D1020- |
| Customer: | |

| | | | | | | | | | |
|-------|--------|------|--------|--------|--------|-----------|-----------|------|------------|
| DRW: | Jason | CHKD | Wilson | MATL: | Wilson | TOLERANCE | Mason | DATE | 30.04.2017 |
| APPD: | Schumi | | | FINISH | Jamy | | Sheet No. | | 3 from 4 |

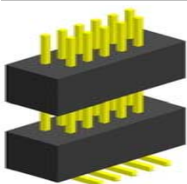

Soldering Profile for Lead Soldering (P.B.T.)

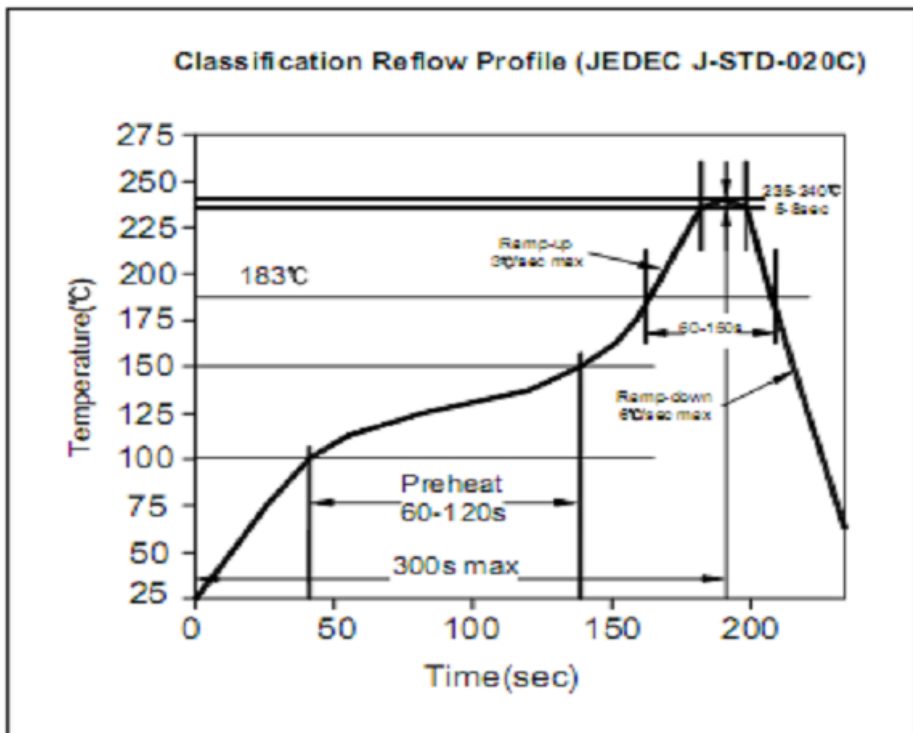

Soldering Profile for Lead Free Soldering (Nylon 6T)

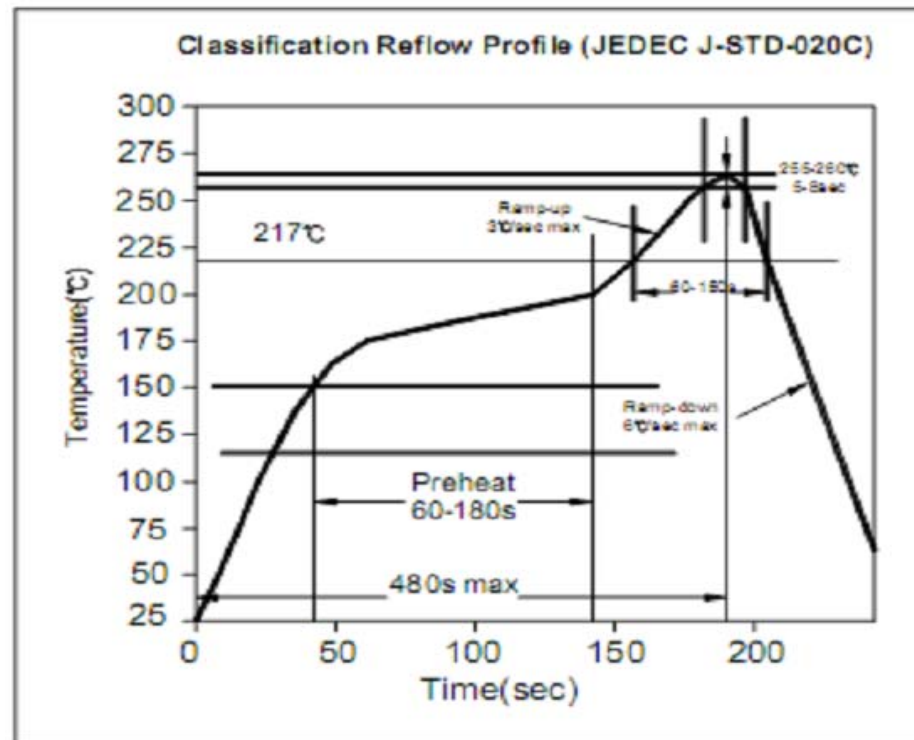

**THT PIN Header / Pitch
1,0x1,0mm**

Part No.: **T51D1020-**

| | | | | | | | | | |
|-------|--------|------|--------|--------|--------|-----------|-----------|----------|------------|
| DRW: | Jason | CHKD | Wilson | MATL: | Wilson | TOLERANCE | Mason | DATE | 30.04.2017 |
| APPD: | Schumi | | | FINISH | Jamy | | Sheet No. | 4 from 4 | Customer: |