

EDCON-COMPONENTS

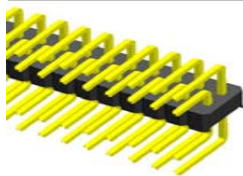

Specifications

Current Rating:	3 Ampere
Insulator Resistance:	5000 Megaohm min.
Contact Resistance	20m Ohm max.
Dielectric Withstanding:	AC 500V
Operating Temperature:	-.65°C to +125°C
Contact Material:	Brass
Insulator Material:	Polyester, UL 94V-0
Standard:	PBT
Contact Plating:	Tin, Gold or Selective Plated
Standard:	Gold Flash Overall

P.C.B Layout

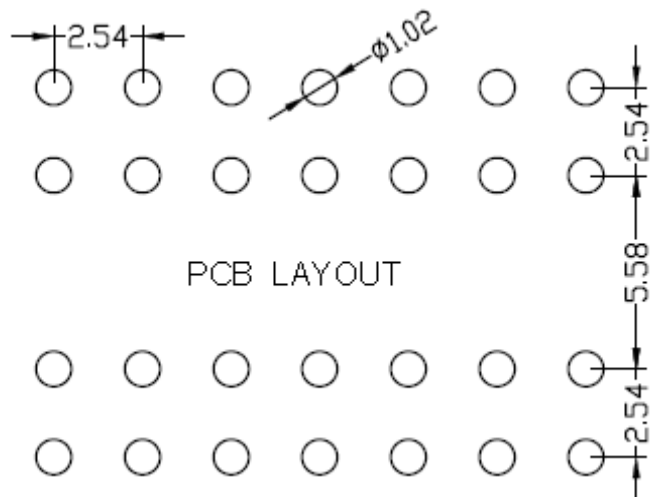

Drawing

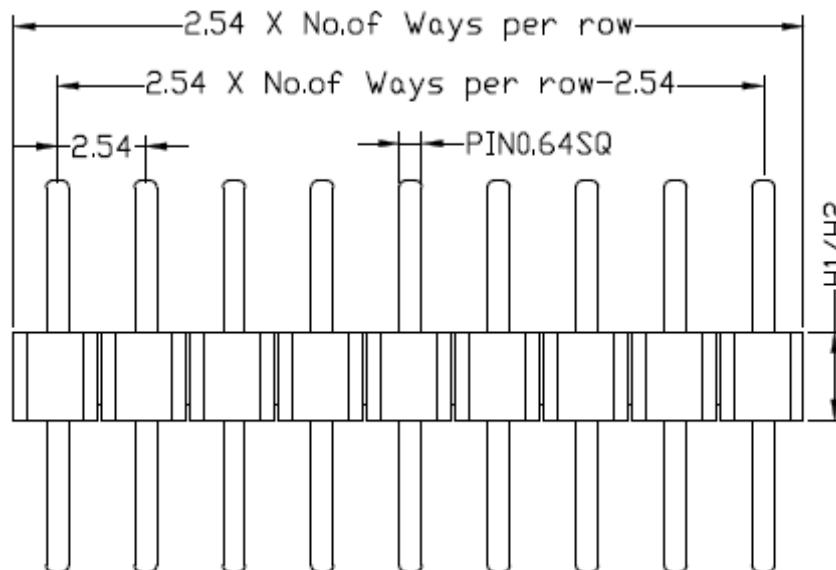

Male Header Pitch 2,54mm

Part No.: **T51A1085-**

DRW:	Jason	CHKD	Wilson	MATL:	Wilson	TOLERANCE	Mason	DATE	01.10.2017	Customer:
APPD:	Schumi			FINISH	Jamy		Sheet No.	1 from 4		

EDCON-COMPONENTS

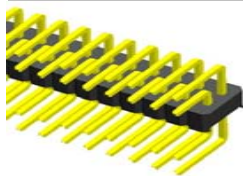

Pin Code length table free configuration

Order Code	Dimension (mm)		
	A	D	
A01	3,00	1,20	
A02			
A03			
A04			
A05			
A06			
A07			
A08			
A09			
A10			
A11			
A12			
A13			
A14			
A15			
A16			
A17			
A18			
A19			
A20			
A21			
A22			

Order Code	Dimension (mm)		
	A	D1	
A23			
A24			
A25			
A26			
A27			
A28			
A29			
A30			
A31			
A32			
A33			
A34			
A35			
A36			
A37			
A38			
A39			
A40			
A41			
A42			
A43			
A44			

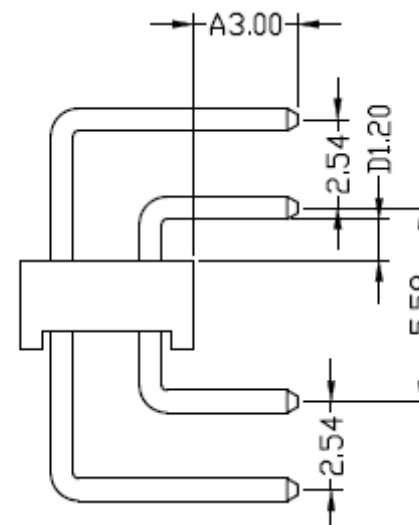

Male Header Pitch 2,54mm

DRW:	Jason	CHKD	Wilson	MATL:	Wilson	TOLERANCE	X=	X.X=	X.XX=	X.XXX=
APPD:	Schumi			FINISH	Jamy		±0,35	±0,25	±0,20	±0,15
								Mason	DATE	01.10.2017
									Sheet No.	2 from 4

Part No.: **T51A1085-**

Customer:

EDCON-COMPONENTS

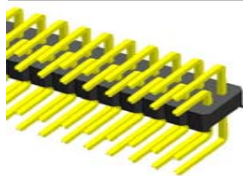

Ordering Informations

Serie	No. of Pos.	Construction	Contact Plating	Material	Special function	Pin Length Code	ROHS	Packing		
T51A1085-	XX	RT	G0	PB	2	A01	R	BU		

02 ~ 40Pos.	RT= Right angle THT	G0= Gold Flash (Standard)	PB= P.B.T	1= Plastic Thickness 2,00mm 2= Plastic Thickness 2,54mm	look Table No. 1	N= NO ROHS conform	BU= Bulk (Standard)
	T0= Tin plated	NY= Nylon-6T	R= ROHS conform			TU= Tube w/o Cap	
	T0= Tin plated	PA= PA-46	TC= Tube w. pic and Place Cap				
	GA= 3µ Gold Plating	LC= LCP	TY= Tray packing w/o Cap				
	GB= 5µ Gold Plating		TR= Tape/Reel w. pic and Place Cap				
	GC= 10µ Gold Plating						
	GD= 15µ Gold Plating						
	GE= 20µ Gold Plating						
	GF= 30µ Gold Plating						
	S0= Selectiv Plating Gold Flash / Tin						

Male Header Pitch 2,54mm

Part No.: **T51A1085-**

DRW:	Jason	CHKD	Wilson	MATL:	Wilson	TOLERANCE	Mason	DATE	01.10.2017
APPD:	Schumi			FINISH	Jamy		Sheet No.		3 from 4

Customer:

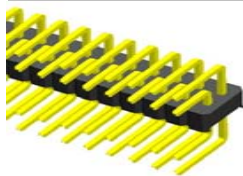

Soldering Profile for Lead Soldering (P.B.T.)

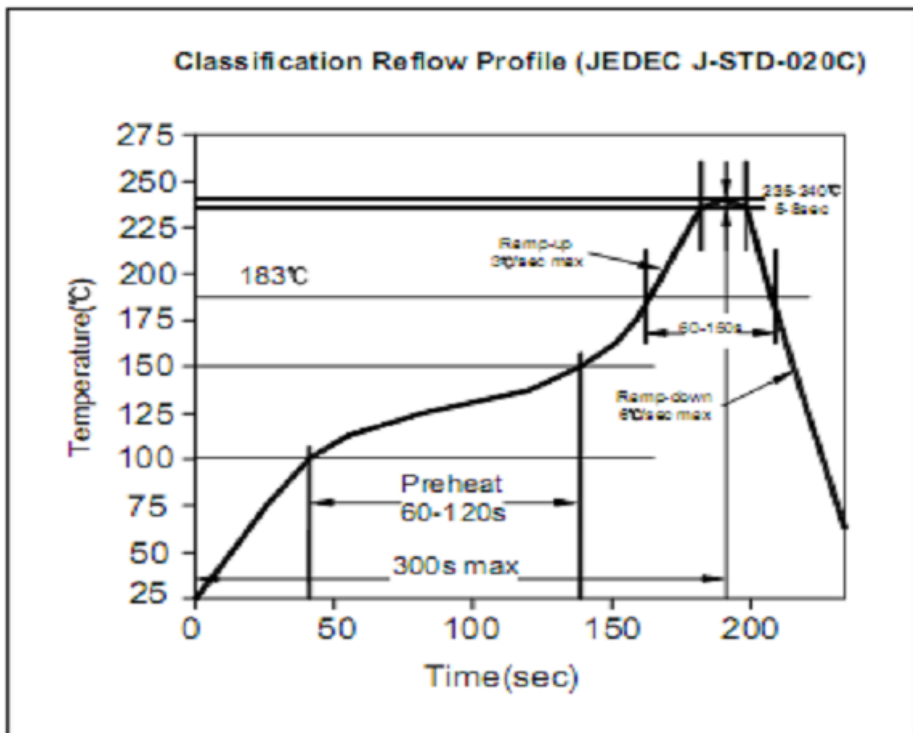

Soldering Profile for Lead Free Soldering (Nylon 6T)

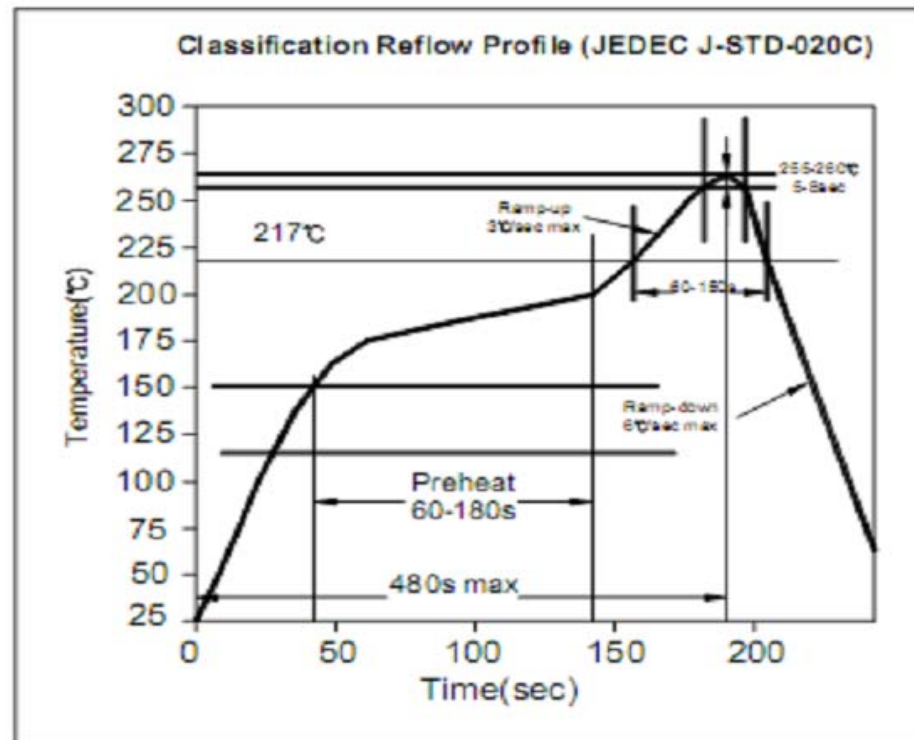

Male Header Pitch 2,54mm

Part No.: T51A1085-

DRW:	Jason	CHKD	Wilson	MATL:	Wilson	TOLERANCE	Mason	DATE	01.10.2017
APPD:	Schumi			FINISH	Jamy		Sheet No.	4 from 4	Customer: