

EDCON-COMPONENTS

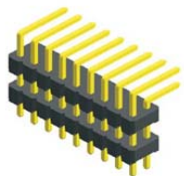

Specifications

Current Rating:	3 Ampere
Insulator Resistance:	5000 Megaohm min.
Contact Resistance	20m Ohm max.
Dielectric Withstanding:	AC 500V
Operating Temperature:	.-65°C to +125°C
Contact Material:	Phosphor Bronze
Insulator Material:	Polyester, UL 94V-0
Standard:	PBT
Contact Plating:	Tin, Gold or Selective Plated
Standard:	Gold Flash Overall

P.C.B Layout

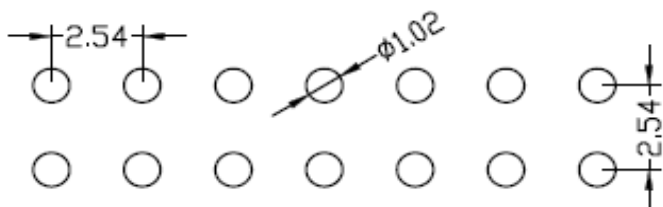

Drawing

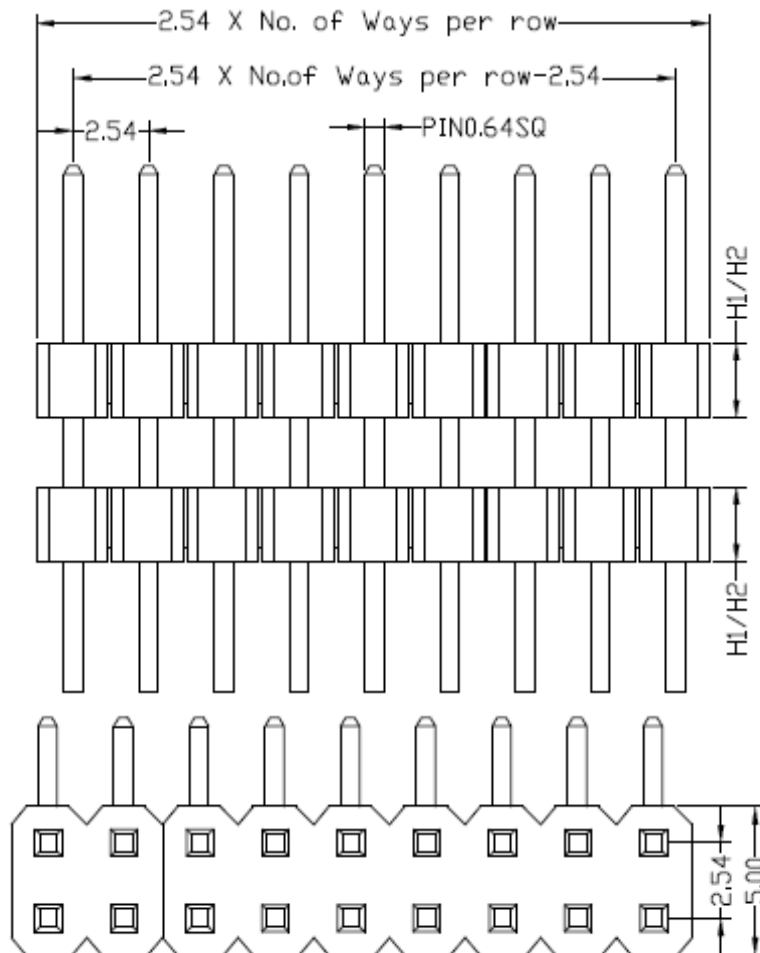

Male Header Pitch 2,54mm

Part No.: **T51A1074-**

Customer:

DRW:	Jason	CHKD	Wilson	MATL:	Wilson	TOLERANCE	Mason	DATE	01.10.2017
APPD:	Schumi			FINISH	Jamy		Sheet No.		1 from 4

EDCON-COMPONENTS

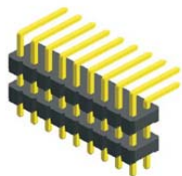

Pin Code length table free configuration

Order Code	Dimension (mm)			
	A	B	C	D
A01	6,00	3,00	7,60	1,20
A02	8,00	3,00	7,60	1,20
A03				
A04				
A05				
A06				
A07				
A08				
A09				
A10				
A11				
A12				
A13				
A14				
A15				
A16				
A17				
A18				
A19				
A20				
A21				
A22				

Order Code	Dimension (mm)			
	A	B	C	
A23				
A24				
A25				
A26				
A27				
A28				
A29				
A30				
A31				
A32				
A33				
A34				
A35				
A36				
A37				
A38				
A39				
A40				
A41				
A42				
A43				
A44				

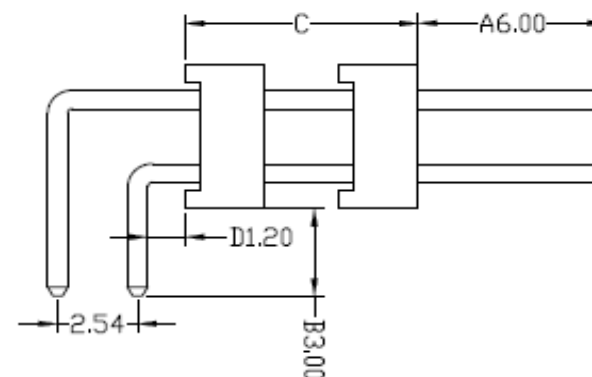

Male Header Pitch 2,54mm

						X=	X.X=	X.XX=	X.XXX=	Part No.:
DRW:	Jason	CHKD	Wilson	MATL:	Wilson	±0,35	±0,25	±0,20	±0,15	T51A1074-
APPD:	Schumi			FINISH	Jamy	TOLERANCE	Mason	DATE	01.10.2017	Customer:
						Sheet No.			2 from 4	

EDCON-COMPONENTS

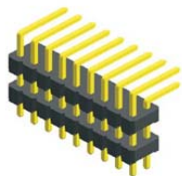

Ordering Informations

Serie	No. of Pos.	Construction	Contact Plating	Material	Special function	Pin Length Code	ROHS	Packing		
T51A1074-	XX	RT	G0	PB	1	A01	R	BU		

02 ~ 40Pos.	RT= Right angle THT	G0= Gold Flash (Standard)	PB= P.B.T	1= Plastic Thickness 2,00mm 2= Plastic Thickness 2,54mm	look Table No. 1	N= NO ROHS conform	BU= Bulk (Standard)
	T0= Tin plated	NY= Nylon-6T	PA= PA-46			R= ROHS conform	TU= Tube w/o Cap
	T0= Tin plated	LC= LCP		TC= Tube w. pic and Place Cap			
	GA= 3µ Gold Plating		TY= Tray packing w/o Cap				
	GB= 5µ Gold Plating	TR= Tape/Reel w. pic and Place Cap					
	GC= 10µ Gold Plating						
	GD= 15µ Gold Plating						
	GE= 20µ Gold Plating						
	GF= 30µ Gold Plating						
	S0= Selectiv Plating Gold Flash / Tin						

Male Header Pitch 2,54mm

Part No.: **T51A1074-**

DRW:	Jason	CHKD	Wilson	MATL:	Wilson	TOLERANCE	Mason	DATE	01.10.2017
APPD:	Schumi			FINISH	Jamy		Sheet No.		3 from 4

Customer:

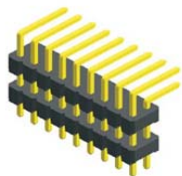

Soldering Profile for Lead Soldering (P.B.T.)

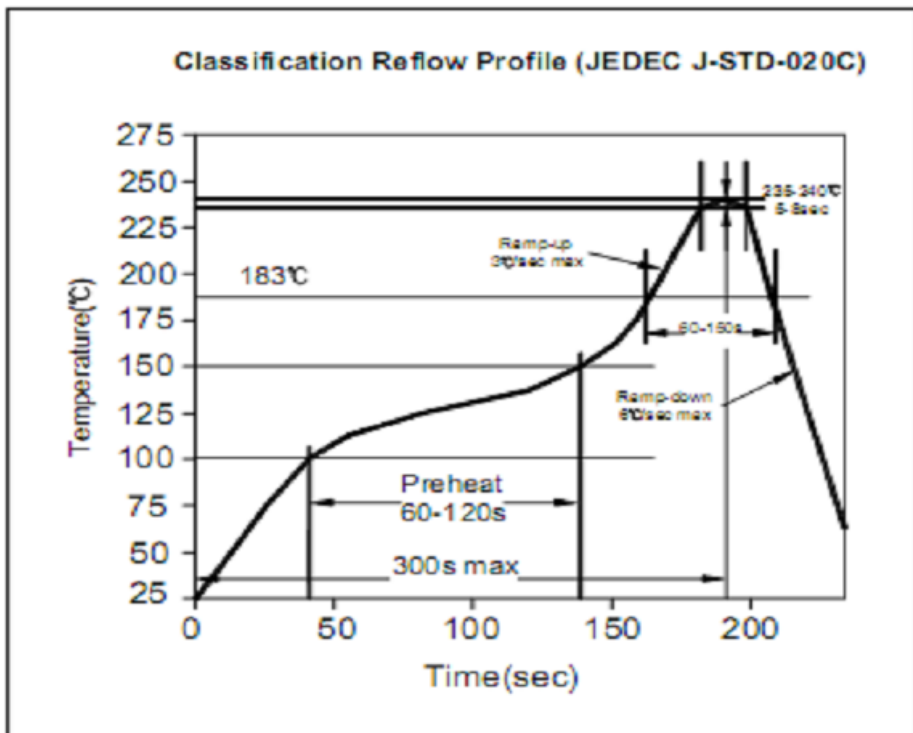

Soldering Profile for Lead Free Soldering (Nylon 6T)

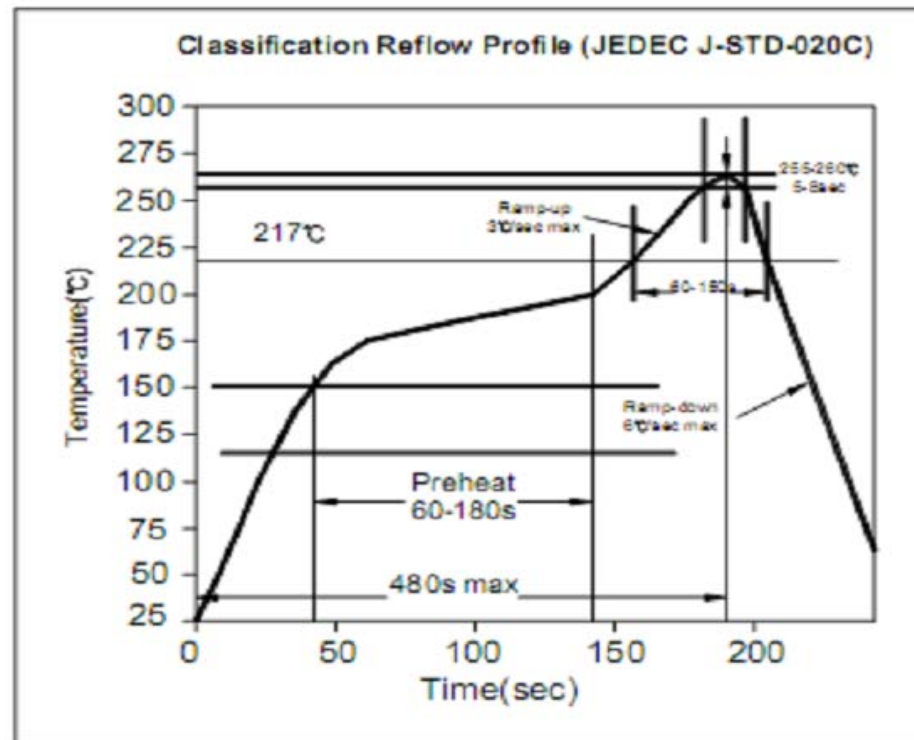

Male Header Pitch 2,54mm

Part No.: **T51A1074-**

DRW:	Jason	CHKD	Wilson	MATL:	Wilson	TOLERANCE	Mason	DATE	01.10.2017
APPD:	Schumi			FINISH	Jamy		Sheet No.	4 from 4	Customer: