



DISCRIPTION

FEATURES

Flat-top for Pick & Place
 Very low DC Resistance
 Low Profile

OPTIONS

Tape & Reel is Standard
 Bulk Packing Available for smaller quantities
 Tolerance: K=10% ; M=20% is Standard

APPLICATIONS

Ideal for High Current,
 Low Voltage DC - DC Converters
 Designed for 3,3V Microprocessor

PHYSICAL CHARACTERISTICS

- Open Circuit Inductance Test Parameters : 100KHz , 250Vrms, 0,0 Adc.
- RMS current for an approximate ΔT of 40°C at an ambient temperature of 85°C
- Peak current for approximately 30% rolloff
- DCR limits 20°C
- Operating Temperature : -40°C to +85°C

ELECTRICAL SPECIFICATIONS

Properties	Test conditions		Value	Unit	Tol.
Inductance		L	68	μ H	see Site 2
Q factor		Q	---		min.
DC-resistance		DCR typ.	---	Ω	typ.
DC-resistance		DCR max.	0,7320	Ω	max.
Self-Res. Freq.		SRF	---	MHz	min.
Test-Freq.			---	MHz	
Rated Current		IRMS	0,67	A	max.
Saturation Current		I SAT	0,67	A	max.

1. This electronic component is meant to be used in general electronic equipment. Before the incorporation of this component into any equipment with higher and more reliable requirements such as aviation, aerospace, submarine, nuclear control, transportation, transportation signal, disaster prevention, medical, public information network, etc. or if there is a possibility of injuries or damages to the human body, Edcon -Components must be informed before the stage of design-in. Evaluation checks for safety have to be performed on each electronic components used in electrical circuits that require high safety and reliability functions.

SMT HIGH CURRENT INDUCTOR

Part No.: **S23001-680**

Customer:

DRW:	Chang	CHKD	Young	MATL:	Chu Chi	DATE	17.06.2009
APPD:	Pong			FINISH	Vienna	Sheet	1 from 2



TECHNICAL INFORMATIONS

Dimensions (mm)

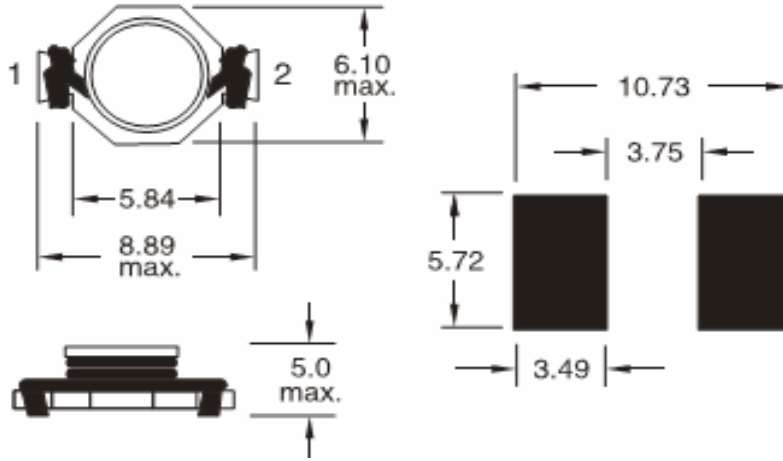

Ordering Information

Serie and Range	Tolerance	ROHS	Packing
S23001-680	M	R	TR
	K = 10%	R = ROHS	BU = Bulk Ware
	M = 20%	N = non ROHS	TR = Tape Reel

**Soldering Profile for Lead Free Soldering
 235-240°C**

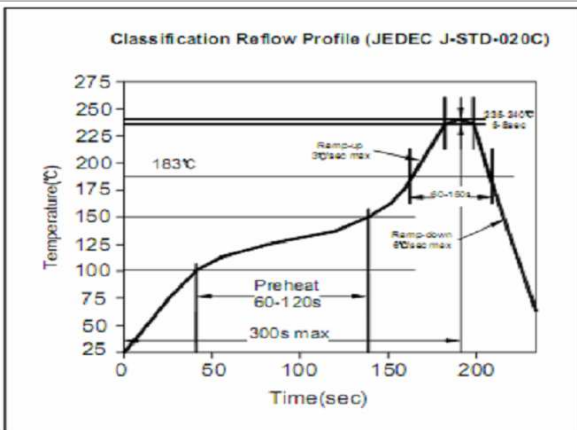

**Soldering Profile for Lead Free Soldering
 255-260°C**



1. This electronic component is meant to be used in general electronic equipment. Before the incorporation of this component into any equipment with higher and more reliable requirements such as aviation, aerospace, submarine, nuclear control, transportation, transportation signal, disaster prevention, medical, public information network, etc. or if there is a possibility of injuries or damages to the human body, Edcon -Components must be informed before the stage of design-in. Evaluation checks for safety have to be performed on each electronic components used in electrical circuits that require high safety and reliability functions.

**SMT HIGH CURRENT
 INDUCTOR**

Part No.: **S23001-680**

Customer:

DRW:	Chang	CHKD	Young	MATL:	Chu Chi	DATE	17.06.2009
APPD:	Pong			FINISH	Vienna	Sheet	2 from 2