

EDCON-COMPONENTS

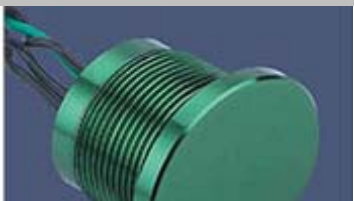

ELECTRICAL SPECIFICATION:

Current Rating: 200mA / 24VAC/DC
1A / 24VAC/DC
depending on Version

Switch Resistance ON: 10mOhm max.

Switch Resistance OFF: 5 MOhm min.

Operating force: 2 to 6N

Life Expectancy: 50 Million cycles

LED Consumption: Illuminated DOT 10mA
Illuminated RING 20mA

Material SPECIFICATION:

Case: Aluminium , Anodized

Terminals: Multi-wire leads section 0,22
Standard Length 300mm
Twisted by pair

Terminals: Bronze, tin plated

Environmental Specifications

Sealing: IP68

Vibration Resistance: 10~500Hz/10g

Operating Temperature: -40°C to + 75°C

Wiring Diagramm

Momentary NO

Non-illuminated

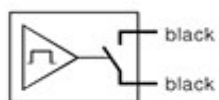

1 LED*

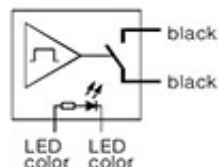

Drawing

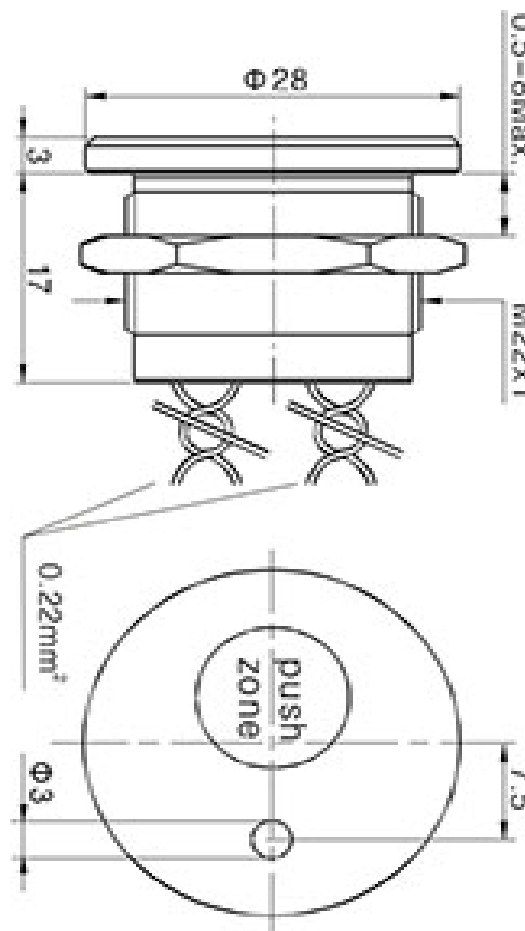

Piezo Switch 22mm w. POINT-Illuminated

Part No.: **Q72027**

Customer:

DRW:	Jason	CHKD	Wilson	MATL:	Wilson	TOLERANCE	Mason	DATE	06.03.2017
APPD:	Schumi			FINISH	Jamy		Sheet No.		1 from 3

www.edcon-components.com

email: info@edcon-components.com

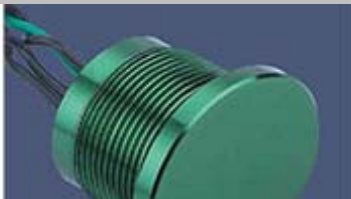

Finger pressure applied to switch

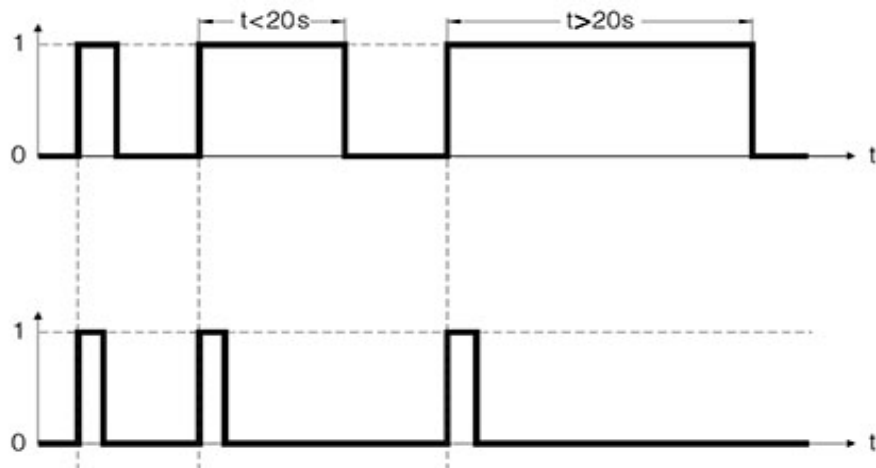

1= Pressure
0= No Pressure

Output
- Momentary NO (Pulse)
No external Power supply required

Piezo Switch 22mm w. POINT-Illuminated	
Part No.:	Q72027
Customer:	

DRW:	Jason	CHKD	Wilson	MATL:	Wilson	TOLERANCE	Mason	DATE	06.03.2017
APPD:	Schumi			FINISH	Jamy		Sheet No.	2 from 3	

www.edcon-components.com

email: info@edcon-components.com

Copyright by S.Tiede

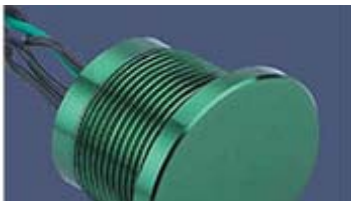

Ordering Informations

Serie	Knop Type	Electrical Function	Terminal Option	Crust Material	Colour Material	Electrical Ratings	LED Colour	LED Voltage	Special function	ROHS Conform	Packing
Q72027	B	1	A1	AL	A0	A	N	00	N	R	BU

B= 3,0mm Thickness Operator	1= NO (Pulse)	A1= 300mm Wire Length	AL= Aluminium	A0= Natural Aluminium	A= 200mA 24VAC/DC	R= Red	00= No function	N= No special function	R= ROHS Conform	BU= Bulk-Ware
		Ax= xxxmm Wire on Request	SS= Stainless Steel	A1= Blue anodized Aluminium		G= Green	05= 5Volt		N= NON ROHS Conform	IV= Individual Package
				A2= Black anodized Aluminium		Y= Yellow	12= 12Volt			
				A3= Gold anodized Aluminium		O= Orange	24= 24Volt			
				A4= Green anodized Aluminium		B= Blue				
				A5= Red anodized Aluminium		W= White				
				SS= Stainless Steel Natural		N= Non Illuminated				

Piezo Switch 22mm w. POINT-Illuminated	
Part No.:	Q72027
Customer:	

DRW:	Jason	CHKD	Wilson	MATL:	Wilson	TOLERANCE	Mason	DATE	06.03.2017
APPD:	Schumi			FINISH	Jamy		Sheet No.		3 from 3