

EDCON-COMPONENTS



Designed for surface mounting on high density circuit board

Emboss carrier tape packing systems is available for automatic insertion



Technical Informations

Voltage:	6,3Volt
Range;	47µF
Dimension; D x L mm	5x5.8mm
Impedance (Ω) max., at20°C, 100hKz	no specified
Ripple Current (mA rms) at 105°C, 100kHz	33mA

Ordering Code			
6V3	Voltage		
470	Range		
D=	B	L=	1

Operating Temperatur Range of -55°C ~ +105°C

Load Life of 2000~3000 hours at 105°C

Leakage current max.	Ø4 ~ Ø10mm	I= 0,01CV or 3µA whichever is greater (after 2 minutes)								
	Ø12,5 ~ Ø16mm	I= 0,03CV or 4µA whichever is greater (after 1 minutes)								
Capacitance tolerance	± 20% at 120Hz, 20°C									
Dissipation factor max. (at 120Hz, 20°C)	WV		6,3	10	16	25	35	50		
	Tanδ	Ø4 ~ Ø10mm	0,28	0,24	0,20	0,16	0,13	0,12		
		Ø12,5 ~ Ø16mm	0,38	0,34	0,30	0,26	0,22	0,18		

Low Temperatur characteristics (Impedance ratio at 120Hz)	WV		6,3	10	16	25	35	50		
	Ø4 ~ Ø10mm	Z-25°C / Z+20°C	3	3	2	2	2	2		
		Z-40°C / Z+20°C	8	5	4	3	3	3		
	Ø12,5 ~ Ø16mm	Z-25°C / Z+20°C	5	4	3	2	2	2		
Z-40°C / Z+20°C		12	10	8	5	4	3			

Load Life (after aplication of the rated voltage for 1000hrs at 105°C	Leakage current	Less than specified value
	Capacitance Change	Within ±25% of initial value
	Tanδ	Less than 200% of specified value
	Ø4 ~ Ø6,3x5,8; Ø8x6,2 : 2000hours	
Shell life (at 105°C)	After 1000hours no load test, leakage current, capacitance and tanδ are same as load life value.	

**CHIP Long Life Assurance
105°C 3000hrs**

Part No.: **I15006**

DRW:	Jason	CHKD	Wilson	MATL:	Wilson	TOLERANCE	Mason	DATE	19.06.2014
APPD:	Schumi			FINISH	Jamy		Sheet No.		2 from 7

Customer:

EDCON-COMPONENTS



Designed for surface mounting on high density circuit board

Emboss carrier tape packing systems is available for automatic insertion



Resistance to soldering heat	After reflow soldering and resistance at room temperature, they meet the characteristics requirements listed at underside	
	Leakage current	Less than specified value
	Capacitance Change	Within $\pm 10\%$ of initial value
	Tan δ	Less than specified value

FREQUENCY COEFFICIENT OF PERMISSIBLE RIPPLE CURRENT						
Diameter	Capacitance	Frequency				
	μF	50Hz	120Hz	300Hz	1KHz	10KHz \leq
$\varnothing 4 \sim \varnothing 10\text{mm}$	0,1 ~100	0,70	1,00	1,17	1,36	1,50
	150 ~1500	0,85	1,00	1,08	1,20	1,30
$\varnothing 12,5 \sim \varnothing 16\text{mm}$	~470	0,75	1,00	1,35	1,57	2,00
	680 ~3300	0,50	1,00	1,23	1,34	1,50

CHIP Long Life Assurance 105°C 3000hrs	
Part No.:	I15006
Customer:	

DRW:	Jason	CHKD	Wilson	MATL:	Wilson	TOLERANCE	Mason	DATE	19.06.2014
APPD:	Schumi			FINISH	Jamy		Sheet No.		3 from 7

EDCON-COMPONENTS



Designed for surface mounting on high density circuit board

Emboss carrier tape packing systems is available for automatic insertion



Technical Drawing

Dimension of Size $\varnothing 8 \times 10,5 \sim 16 \text{mm}$



Dimension of Size $\varnothing 4 \sim 8 \times 6,2 \text{mm}$

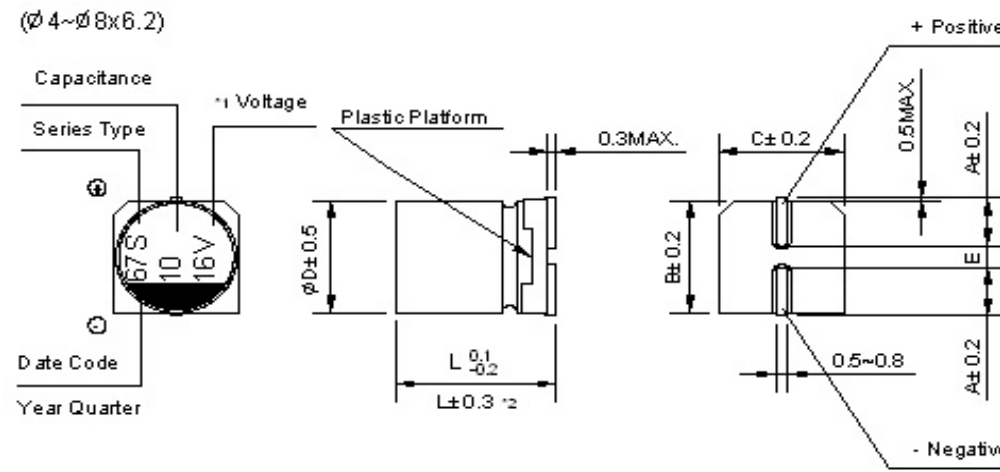

D x L	$\varnothing 4 \times 5,8$	$\varnothing 5 \times 5,8$	$\varnothing 6,3 \times 5,8$	$\varnothing 6,3 \times 7,7$	$\varnothing 8 \times 6,2$	$\varnothing 8 \times 10,5$	$\varnothing 10 \times 10,5$	$\varnothing 10 \times 13,5$	$\varnothing 12,5 \times 13,5$	$\varnothing 12,5 \times 16$	$\varnothing 16 \times 16,5$
A	2,0	2,2	2,6	2,6	3,4	3,0	3,3	3,3	4,9	4,9	5,8
B	4,3	5,3	6,6	6,6	8,4	8,4	10,4	10,4	13,0	13,0	17,0
C	4,3	5,3	6,6	6,6	8,4	8,4	10,4	10,4	13,0	13,0	17,0
E +/-0.2	1,0	1,3	1,9	1,9	2,3	3,1	4,7	4,7	4,7	4,7	6,4
L	5,8	5,8	5,8	7,7	6,2	10,5	10,5	13,5	13,5	16,0	16,5

*1 Voltage mark (6V) represents 6,3V for $\varnothing 4 \sim 10 \text{mm}$

*3 (L +/- 0.5) is applicable to $\varnothing 8 \times 10,5 \sim \varnothing 10 \text{mm}$

*2 (L +/- 0.3) is applicable to $\varnothing 6,3 \sim 7,7$ and $\varnothing 8 + 6,2 \text{mm}$

*4 (L +/- 1.0) is applicable to $\varnothing 12,5 \sim \varnothing 16 \text{mm}$

RE. Date code and seriew type -1st digit for Year 2nd digit for Quarter, 4 quarter codes in one year area 1,4,7,0

3rd character for Serie S

CHIP Long Life Assurance
105°C 3000hrs

Part No.: **I15006**

DRW:	Jason	CHKD	Wilson	MATL:	Wilson	TOLERANCE	Mason	DATE	19.06.2014	Customer:
APPD:	Schumi			FINISH	Jamy		Sheet No.	4 from 7		

www.edcon-components.com

email: info@edcon-components.com

EDCON-COMPONENTS



Designed for surface mounting on high density circuit board

Emboss carrier tape packing systems is available for automatic insertion



Ordering Informations

Serie	Voltage Code	Tolerance Code	Range Code	Size Code D	Size Code L	Special function	ROHS	Packing Code		
-------	--------------	----------------	------------	-------------	-------------	------------------	------	--------------	--	--

I15006	6V3	M	470	B	1	XX	R	TR		
---------------	------------	----------	------------	----------	----------	-----------	----------	-----------	--	--

look table Voltage Code	M= ±20%	Ordering Code Range	Look table Code D	Look table Code L	XX= No function	R= ROHS Conform N= NON ROHS Conform	TR= Tape Reel Packing BU= Bulk-Ware		
-------------------------	----------------	---------------------	-------------------	-------------------	------------------------	--	--	--	--

CHIP Long Life Assurance	
105°C 3000hrs	
Part No.:	I15006
Customer:	

DRW:	Jason	CHKD	Wilson	MATL:	Wilson	TOLERANCE	Mason	DATE	19.06.2014
APPD:	Schumi			FINISH	Jamy		Sheet No.		6 from 7

EDCON-COMPONENTS



Designed for surface mounting on high density circuit board
 Emboss carrier tape packing systems is available for automatic insertion



Soldering Profile Curve

Classification Reflow Profile (JEDEC J-STD-020C)



CHIP Long Life Assurance	
105°C 3000hrs	
Part No.:	I15006
Customer:	

DRW:	Jason	CHKD:	Wilson	MATL:	Wilson	TOLERANCE:	Mason	DATE:	19.06.2014
APPD:	Schumi			FINISH:	Jamy		Sheet No.		7 from 7