



# EDCON-COMPONENTS



Designed for surface mounting on high density circuit board

Emboss carrier tape packing systems is available for automatic insertion



## Technical Informations

Voltage:	<b>50Volt</b>
Range:	<b>100µF</b>
Dimension; D x L mm	<b>10x10,5mm</b>
Impedance (Ω) max., at20°C, 100hKz	<b>no specified</b>
Ripple Current (mA rms) at 105°C, 100kHz	<b>100mA</b>

Ordering Code			
<b>500</b>	<b>Voltage</b>		
<b>101</b>	<b>Range</b>		
<b>D=</b>	<b>G</b>	<b>L=</b>	<b>4</b>

Operating Temperatur Range of -55°C ~ +105°C

Load Life of 2000~3000 hours at 105°C

<b>Leakage current max.</b>	Ø4 ~ Ø10mm	I= 0,01CV or 3µA whichever is greater ( after 2 minutes)								
	Ø12,5 ~ Ø16mm	I= 0,03CV or 4µA whichever is greater ( after 1 minutes)								
<b>Capacitance tolerance</b>	± 20% at 120Hz, 20°C									
<b>Dissipation factor max. (at 120Hz, 20°C)</b>	WV		6,3	10	16	25	35	50		
	Tanδ	Ø4 ~ Ø10mm	0,28	0,24	0,20	0,16	0,13	0,12		
		Ø12,5 ~ Ø16mm	0,38	0,34	0,30	0,26	0,22	0,18		

<b>Low Temperatur characteristics ( Impedance ratio at 120Hz )</b>	WV		6,3	10	16	25	35	50		
	Ø4 ~ Ø10mm	Z-25°C / Z+20°C	3	3	2	2	2	2		
		Z-40°C / Z+20°C	8	5	4	3	3	3		
	Ø12,5 ~ Ø16mm	Z-25°C / Z+20°C	5	4	3	2	2	2		
Z-40°C / Z+20°C		12	10	8	5	4	3			

<b>Load Life ( after aplication of the rated voltage for 1000hrs at 105°C</b>	Leakage current	Less than specified value
	Capacitance Change	Within ±25% of initial value
	Tanδ	Less than 200% of specified value
	Ø4 ~ Ø6,3x5,8; Ø8x6,2 : 2000hours	
<b>Shell life (at 105°C)</b>	After 1000hours no load test, leakage current, capacitance and tanδ are same as load life value.	

**CHIP Long Life Assurance  
105°C 3000hrs**

Part No.: **I15006**

DRW:	Jason	CHKD	Wilson	MATL:	Wilson	TOLERANCE	Mason	DATE	19.06.2014
APPD:	Schumi			FINISH	Jamy		Sheet No.		2 from 7

Customer:

# EDCON-COMPONENTS



Designed for surface mounting on high density circuit board

Emboss carrier tape packing systems is available for automatic insertion



<b>Resistance to soldering heat</b>	After reflow soldering and resistance at room temperature, they meet the characteristics requirements listed at underside	
	Leakage current	Less than specified value
	Capacitance Change	Within $\pm 10\%$ of initial value
	Tan $\delta$	Less than specified value

FREQUENCY COEFFICIENT OF PERMISSIBLE RIPPLE CURRENT						
Diameter	Capacitance	Frequency				
	$\mu\text{F}$	50Hz	120Hz	300Hz	1KHz	10KHz $\leq$
$\varnothing 4 \sim \varnothing 10\text{mm}$	0,1 ~100	0,70	1,00	1,17	1,36	1,50
	150 ~1500	0,85	1,00	1,08	1,20	1,30
$\varnothing 12,5 \sim \varnothing 16\text{mm}$	~470	0,75	1,00	1,35	1,57	2,00
	680 ~3300	0,50	1,00	1,23	1,34	1,50

**CHIP Long Life Assurance  
105°C 3000hrs**

Part No.: **I15006**

DRW:	Jason	CHKD	Wilson	MATL:	Wilson	TOLERANCE	Mason	DATE	19.06.2014	Customer:
APPD:	Schumi			FINISH	Jamy		Sheet No.	3 from 7		

# EDCON-COMPONENTS



Designed for surface mounting on high density circuit board

Emboss carrier tape packing systems is available for automatic insertion



## Technical Drawing

### Dimension of Size Ø 8x10,5 ~ 16mm



### Dimension of Size Ø 4~ 8x6,2mm

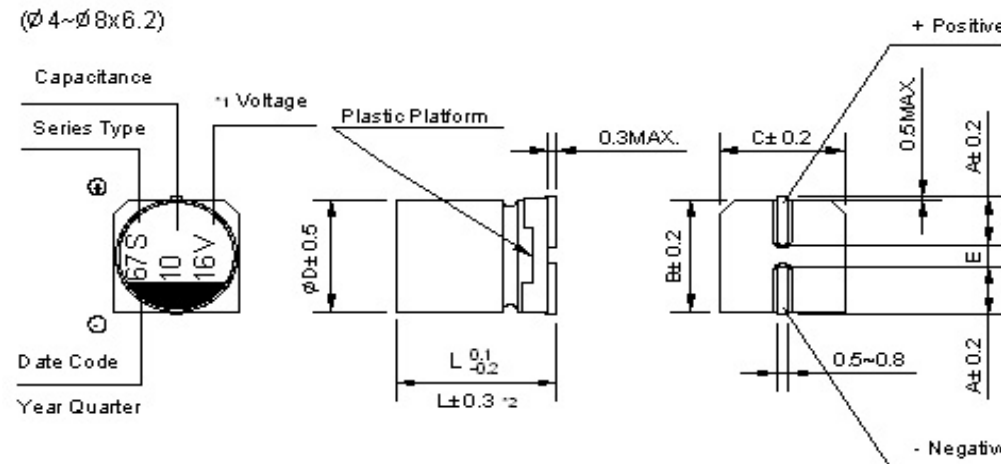

D x L	Ø 4 x 5,8	Ø 5 x 5,8	Ø 6,3 x 5,8	Ø 6,3 x 7,7	Ø 8 x 6,2	Ø 8 x 10,5	Ø 10 x 10,5	Ø 10 x 13,5	Ø 12,5 x 13,5	Ø 12,5 x 16	Ø 16 x 16,5
A	2,0	2,2	2,6	2,6	3,4	3,0	3,3	3,3	4,9	4,9	5,8
B	4,3	5,3	6,6	6,6	8,4	8,4	10,4	10,4	13,0	13,0	17,0
C	4,3	5,3	6,6	6,6	8,4	8,4	10,4	10,4	13,0	13,0	17,0
E +/-0.2	1,0	1,3	1,9	1,9	2,3	3,1	4,7	4,7	4,7	4,7	6,4
L	5,8	5,8	5,8	7,7	6,2	10,5	10,5	13,5	13,5	16,0	16,5

\*1 Voltage mark (6V) represents 6,3V for Ø 4 ~ 10mm

\*3 (L +/- 0.5) is applicable to Ø 8x10,5 ~ Ø 10mm

\*2 (L +/- 0.3) is applicable to Ø 6,3 ~ 7.7 and Ø 8 + 6,2mm

\*4 (L +/- 1.0) is applicable to Ø 12,5 ~ Ø 16mm

RE. Date code and seriew type -1st digit for Year 2nd digit for Quarter, 4 quarter codes in one year area 1,4,7,0

3rd character for Serie S

**CHIP Long Life Assurance**  
**105°C 3000hrs**

Part No.: **I15006**

DRW:	Jason	CHKD	Wilson	MATL:	Wilson	TOLERANCE	Mason	DATE	19.06.2014	Customer:
APPD:	Schumi			FINISH	Jamy		Sheet No.	4 from 7		

[www.edcon-components.com](http://www.edcon-components.com)

email: [info@edcon-components.com](mailto:info@edcon-components.com)



# EDCON-COMPONENTS



Designed for surface mounting on high density circuit board

Emboss carrier tape packing systems is available for automatic insertion



## Ordering Informations

Serie	Voltage Code	Tolerance Code	Range Code	Size Code D	Size Code L	Special function	ROHS	Packing Code		
-------	--------------	----------------	------------	-------------	-------------	------------------	------	--------------	--	--

<b>I15006</b>	<b>500</b>	<b>M</b>	<b>101</b>	<b>G</b>	<b>4</b>	<b>XX</b>	<b>R</b>	<b>TR</b>		
---------------	------------	----------	------------	----------	----------	-----------	----------	-----------	--	--

look table Voltage Code	<b>M= ±20%</b>	Ordering Code Range	Look table Code D	Look table Code L	<b>XX= No function</b>	<b>R= ROHS Conform</b> <b>N= NON ROHS Conform</b>	<b>TR= Tape Reel Packing</b> <b>BU= Bulk-Ware</b>		
-------------------------	----------------	---------------------	-------------------	-------------------	------------------------	--	--	--	--

<b>CHIP Long Life Assurance</b>	
<b>105°C 3000hrs</b>	
Part No.:	<b>I15006</b>
Customer:	

DRW:	Jason	CHKD	Wilson	MATL:	Wilson	TOLERANCE	Mason	DATE	19.06.2014
APPD:	Schumi			FINISH	Jamy		Sheet No.		6 from 7

# EDCON-COMPONENTS



Designed for surface mounting on high density circuit board

Emboss carrier tape packing systems is available for automatic insertion



## Soldering Profile Curve

### Classification Reflow Profile (JEDEC J-STD-020C)

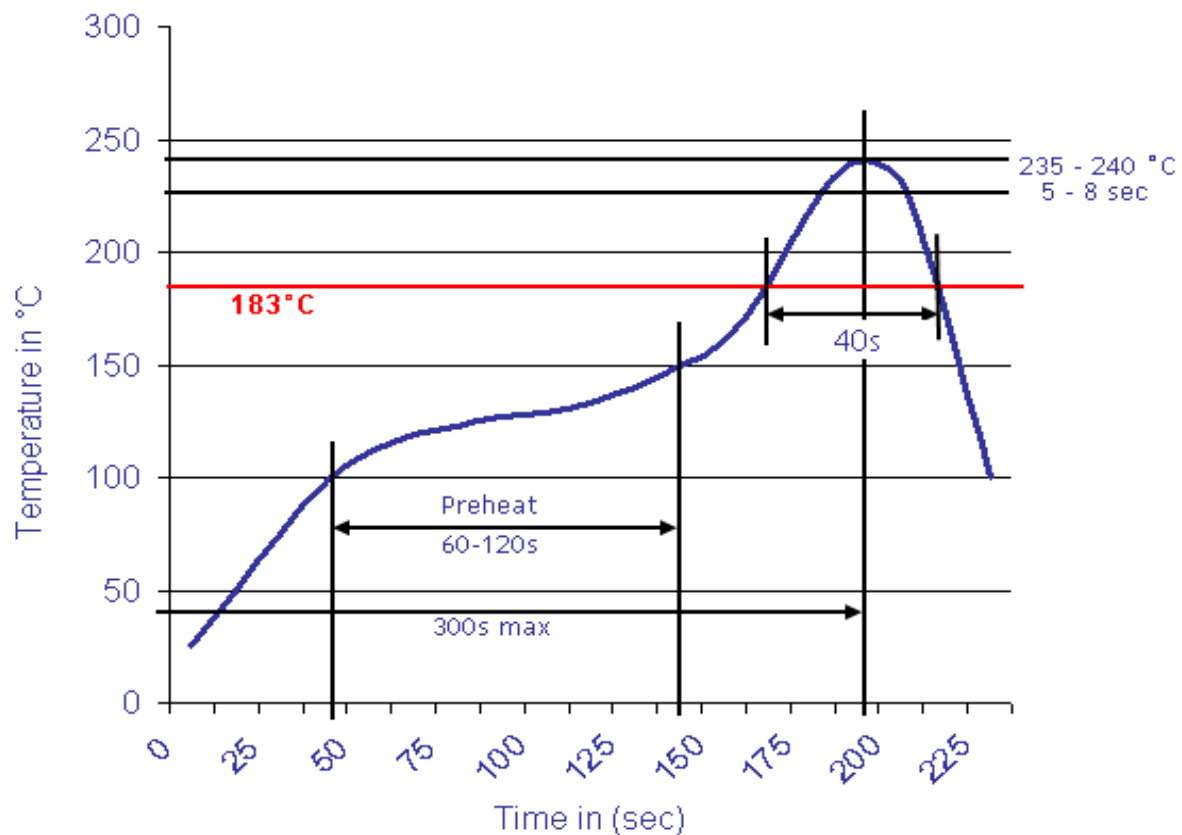

**CHIP Long Life Assurance  
105°C 3000hrs**

Part No.: **I15006**

DRW:	Jason	CHKD	Wilson	MATL:	Wilson	TOLERANCE	Mason	DATE	19.06.2014
APPD:	Schumi			FINISH	Jamy		Sheet No.	7 from 7	

Customer: