

# EDCON-COMPONENTS



Designed for surface mounting on high density circuit board  
 Emboss carrier tape packing systems is available for automatic insertion.



## Technical Description

**Range: (µF)** 470  
**Voltage: (V)** 10  
 Ripple Current of this item: (mA) 320  
 Size of this item: (mm) 10x10,5  
 Operating Temperature: -40°V ~ + 85°C  
 Capacitance Tolerance: +/- 20% at 120Hz, 20°C

Ripple Current at 85°C, 120Hz (mA rms)

### Frequency Correction Factor of Rated Ripple Current

Frequency		50Hz	120Hz	300Hz	1KHz	10Khz
Capacitance	Range					
Ø= 4,0 ~ 10mm	0,1 ~68	0,70	1,00	1,17	1,36	1,50
	100 ~ 3300	0,85	1,00	1,08	1,20	1,30
Ø 12,5 ~ 16mm	~ 68	0,75	1,00	1,35	1,57	2,00
	100 ~ 680	0,80	1,00	1,23	1,34	1,50
	1000 ~ 6800	0,85	1,00	1,10	1,13	1,15

Leakage Current		For Ø 4 ~10mm, after 2 minutes applications of rated voltage, leakage currents is not more than 0,01CV or 3(µA), whichever is greater.										
		For Ø 12,5 ~16mm, after 1 minutes applications of rated voltage, leakage currents is not more than 0,03CV or 4(µA), whichever is greater.										
Tan		Measurement frequency: 120Hz, Temperature: 20°C										
		Rated Voltage (VDC)		4	6,3	10	16	25	35	50	63	100
		Tan δ	Ø4~10mm	0,35	0,26	0,2	0,16	0,14	0,12	0,12	0,1	0,1
Ø12,5~16mm	0,42		0,38	0,34	0,3	0,26	0,22	0,18	0,14	0,1		
Impedance ratio ZT/Z20 (max.)		Stability at Low Temperature: Measurement frequency: 120Hz,										
		Rated Voltage (VDC)		4	6,3	10	16	25	35	50	63	100
		Ø4~10mm	Z(-25°C/Z(20°C)	7	4	3	2	2	2	2	2	2
			Z(-40°C/Z(20°C)	15	8	6	4	4	3	3	3	3
Ø12,5~16mm	Z(-25°C/Z(20°C)	7	5	4	3	2	2	2	2	2		
	Z(-40°C/Z(20°C)	17	12	10	8	5	4	3	3	3		
Load Life	After 2000 hours application of rated value at 85°C, capacitor meet the characteristics requirement listed at right.	Capacitance Change		Within +/-20% of the initial value ( Within +/-30% of the initial value for 4V								
		Tan δ		200% or less of the initial specified value								
		Leakage Current		Initial specified value or less								
Shelf Life		After leaving capacitors under no load at 85°C for 1000hours, they meet the specified value for load life characteristics listed above.										
Resistance to soldering heat	After reflow soldering and restored at room temperature, they meet the characteristics requirements listed at above	Capacitance Change		Within +/-20% of the initial value								
		Tan δ		Initial specified value or less								
		Leakage Current		Initial specified value or less								

Applicable Standards JIS C-5141 and JIS C-5102

## SMT Electrolytic Capacitor Serie SS

Serie No.: I15001

DRW:	Jason	CHKD	Wilson	MATL:	Wilson	TOLERANCE	Mason	DATE	12.02.2010
APPD:	Schumi			FINISH	Jamy		Sheet No.		1 from 10

Customer: email: info@edcon-components.com

[www.edcon-components.com](http://www.edcon-components.com)

# EDCON-COMPONENTS

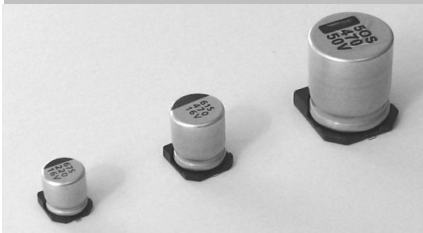

Designed for surface mounting on high density circuit board  
 Emboss carrier tape packing systems is available for automatic insertion.



## Technical Drawing

Dimension of Size Ø 8x10,5 ~ 16mm



Dimension of Size Ø 4~ 8x6,2mm

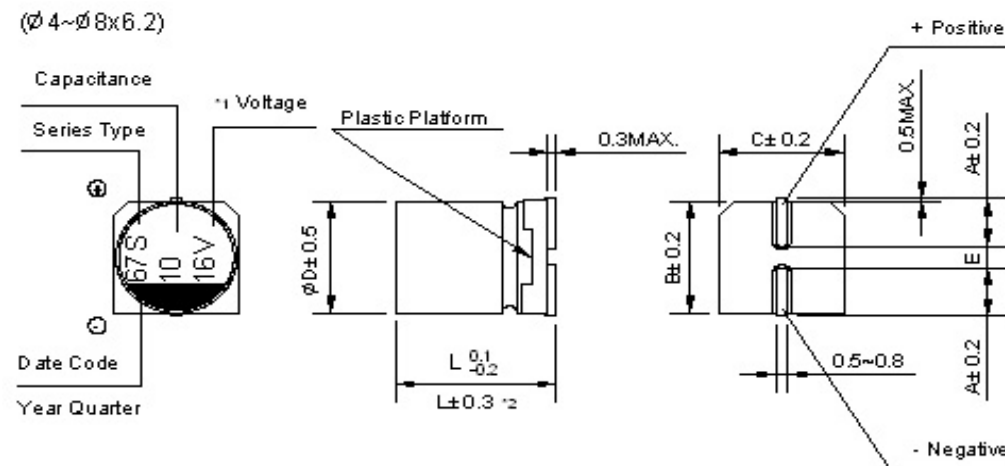

D x L	Ø 4 x 5,4	Ø 5 x 5,4	Ø 6,3 x 5,4	Ø 6,3 x 7,7	Ø 8 x 6,2	Ø 8 x 10,5	Ø 10 x 10,5	Ø 10 x 13,5	Ø 12,5 x 13,5	Ø 12,5 x 16	Ø 16 x 16,5
A	1,8	2,1	2,4	2,4	3,3	2,9	3,2	3,2	4,7	4,7	5,5
B	4,3	5,3	6,6	6,6	8,3	8,3	10,3	10,3	12,8	12,8	16,3
C	4,3	5,3	6,6	6,6	8,3	8,3	10,3	10,3	12,8	12,8	16,3
E +/-0.2	1,0	1,3	2,2	2,2	2,2	3,1	4,4	4,4	4,4	4,4	6,7
L	5,4	5,4	5,4	7,7	6,2	10,5	10,5	13,5	13,5	16,0	16,5

\*1 Voltage mark (6V) represents 6,3V for Ø 4 ~ 10mm

\*3 (L +/- 0.5) is applicable to Ø 8x10,5 ~ Ø 10mm

\*2 (L +/- 0.3) is applicable to Ø 6,3 ~ 7.7 and Ø 8 + 6,2mm

\*4 (L +/- 1.0) is applicable to Ø 12,5 ~ Ø 16mm

RE. Date code and seriew type -1st digit for Year 2nd digit for Quarter, 4 quarter codes in one year area 1,4,7,0

3rd character for Serie S

**SMT Electrolytic Capacitor  
Serie SS**

Serie No.: **I15001**

DRW:	Jason	CHKD	Wilson	MATL:	Wilson	TOLERANCE	Mason	DATE	12.02.2010
APPD:	Schumi			FINISH	Jamy		Sheet No.	2 from 10	Customer:

[www.edcon-components.com](http://www.edcon-components.com)

email: [info@edcon-components.com](mailto:info@edcon-components.com)

# EDCON-COMPONENTS

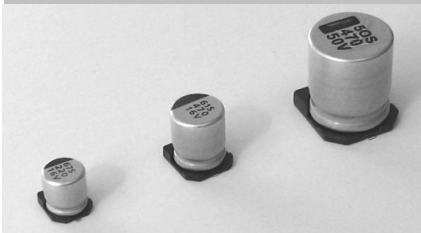

Designed for surface mounting on high density circuit board  
 Emboss carrier tape packing systems is available for automatic insertion.



## Ordering Informations

Serie	Volt	Tolerance	Range	Size Code	Material	Special	ROHS	Packing		
<b>I15001</b>	<b>100</b>	<b>M</b>	<b>471</b>	<b>G0</b>	<b>XX</b>	<b>00</b>	<b>R</b>	<b>TR</b>		

<b>100=</b> 10V	<b>M=</b> Tolerance 20% <b>K=</b> Tolerance 10%	<b>471=</b> 470µF	<b>G0=</b> 10x10,5	<b>XX=</b> No Funktion	<b>00=</b> No Funktion	<b>R=</b> ROHS Conform <b>N=</b> NON ROHS Conform	<b>TR=</b> TAPE Reel <b>BU=</b> Bulk-Ware
-----------------	--	-------------------	--------------------	------------------------	------------------------	--	--

**SMT Electrolytic Capacitor  
 Serie SS**

Serie No.: **I15001**

DRW:	Jason	CHKD	Wilson	MATL:	Wilson	TOLERANCE	Mason	DATE	12.02.2010
APPD:	Schumi			FINISH	Jamy		Sheet No.		3 from 10

Customer:

# EDCON-COMPONENTS



Designed for surface mounting on high density circuit board  
 Emboss carrier tape packing systems is available for automatic insertion.



## Taping Specification

Carrier Type Ø 4 ~ 10mm



Carrier Type Ø 12,5 ~ 16mm

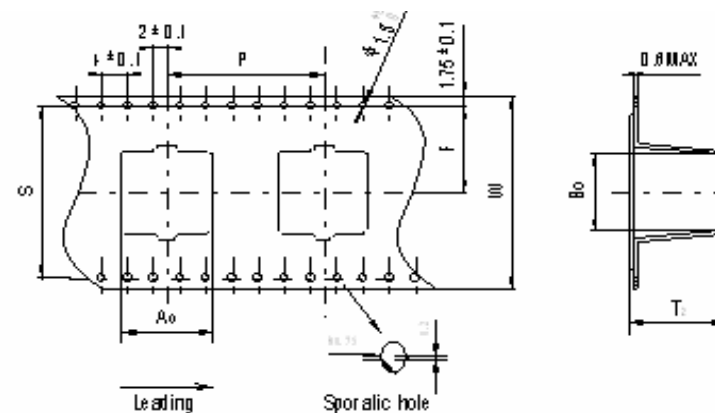

D x L	4x5,4/5,8	5x5,4/5,8	6,3x5,4/5,8	6,3x7,7	8x6,2	8x10,5	10x10,5/13,5	12,5x13,5/16	16x16,5
W	12,0	12,0	16,0	16,0	16,0	24,0	24,0	32,0	44,0
P	8,0	12,0	12,0	12,0	12,0	16,0	16,0	24,0	28,0
F	5,5	5,5	7,5	7,5	7,5	11,5	11,5	14,2	20,2
A0	5,0	6,0	7,0	7,0	8,7	8,7	10,7	14,0	17,5
B0	5,0	6,0	7,0	7,0	8,7	8,7	10,7	14,0	17,5
T2	5,8/6,3	5,8/6,3	5,8/6,3	8,4	6,8	11,0	11,7/14,0	14,0/16,5	17,5
S								28,4	40,4

**SMT Electrolytic Capacitor  
 Serie SS**

Serie No.: I15001

DRW:	Jason	CHKD	Wilson	MATL:	Wilson	TOLERANCE	Mason	DATE	12.02.2010
APPD:	Schumi			FINISH	Jamy		Sheet No.		4 from 10

Customer:

[www.edcon-components.com](http://www.edcon-components.com)

email: info@edcon-components.com

# EDCON-COMPONENTS



Designed for surface mounting on high density circuit board  
 Emboss carrier tape packing systems is available for automatic insertion.



## Taping Specification

Carrier Type  $\varnothing 4 \sim 10\text{mm}$



Carrier Type  $\varnothing 12,5 \sim 16\text{mm}$



D x L	4x5,4/5,8	5x5,4/5,8	6,3x5,4/5,8	6,3x7,7	8x6,2	8x10,5	10x10,5/13,5	12,5x13,5/16	16x16,5
W	12,0	12,0	16,0	16,0	16,0	24,0	24,0	32,0	44,0
P	8,0	12,0	12,0	12,0	12,0	16,0	16,0	24,0	28,0
F	5,5	5,5	7,5	7,5	7,5	11,5	11,5	14,2	20,2
A0	5,0	6,0	7,0	7,0	8,7	8,7	10,7	14,0	17,5
B0	5,0	6,0	7,0	7,0	8,7	8,7	10,7	14,0	17,5
T2	5,8/6,3	5,8/6,3	5,8/6,3	8,4	6,8	11,0	11,7/14,0	14,0/16,5	17,5
S								28,4	40,4

**SMT Electrolytic Capacitor  
 Serie SS**

Serie No.: **I15001**

DRW:	Jason	CHKD	Wilson	MATL:	Wilson	TOLERANCE	Mason	DATE	12.02.2010
APPD:	Schumi			FINISH	Jamy		Sheet No.		5 from 10

Customer:

# EDCON-COMPONENTS

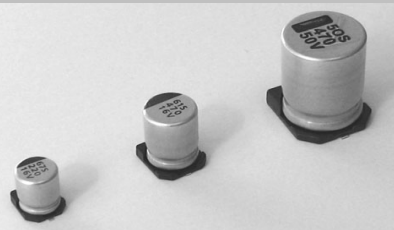

Designed for surface mounting on high density circuit board  
 Emboss carrier tape packing systems is available for automatic insertion.



## Taping Specification

Reel



Box

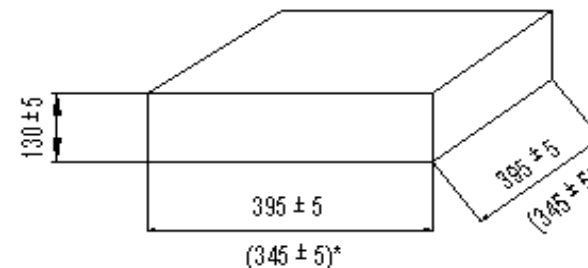

D x L	4x5.4/5.8	5x5.4/5.8	6,3x5,4/5,8/7,7	8x6.2/10.5
A	14	14	18	26
B	382	392	382	382

D x L	10x10,5	10x13,5	12,5x13,5/16	16x16,5
A	26	26	34	46
B	382	382 / 332	382/332	332

Size	Reel (PCS)	In-Box (reels)	Quantity / In-Box (pcs)	4 in-Boxes / Carton (/pcs)
4x5,4/5,8	2000	6	12000	48000
5x5,4/5,8	1000	6	6000	24000
6,3x5,4/5,8	1000	5	5000	20000
6,3x7,7	1000	5	5000	20000
8x6,2	1000	5	5000	20000
8x10,5	500	4	2000	8000
10,x10,5	500	4	2000	8000
10x13,5	300/250	4	1200/1000	4800/4000
12,5x13,5	200/150	3	600/450	2400/1800
12,5x16	200/150	3	600/450	2400/1800
16x16,5	125	2	250	1000

### SMT Electrolytic Capacitor Serie SS

Serie No.: I15001

DRW:	Jason	CHKD	Wilson	MATL:	Wilson	TOLERANCE	Mason	DATE	12.02.2010
APPD:	Schumi			FINISH	Jamy		Sheet No.		6 from 10

Customer:



# EDCON-COMPONENTS



Designed for surface mounting on high density circuit board  
 Emboss carrier tape packing systems is available for automatic insertion.



## Reflow Soldering Conditions

- 1 A thermal condition system such as infrared radiation (IR) or hot blast shall be adopted, and vapor heat transfer systems (VPS) are not recommended.
- 2 Reflow shall be done within 2 cycles. Please make sure that the parts have enough cooling time.
- 3 The time of preheating from 150°C to 200°C shall be within 180 seconds maximum;  
 The time of soldering temperature at 217°C measured on capacitors' top shall not exceed  $t_L$  (second);  
 The peak temperature on capacitors' top shall not exceed  $T_p$ (°C), and the time within 5°C of actual peak temperature shall not exceed  $t_p$  (second).

Reflow Profile

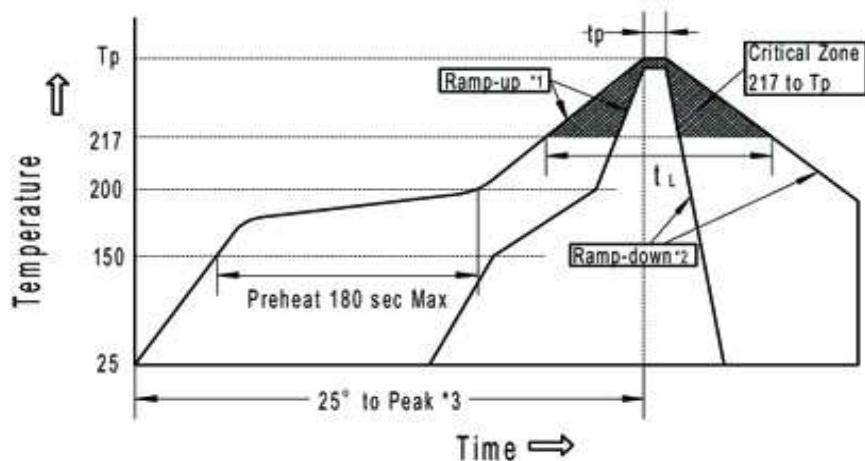

Classified at Temperature and Time for all Products					
Size	Thickness/mm	Volume/mm <sup>3</sup>	Tp (°C)	tl / second	tp / second
Ø 4~ 6,3 & Ø 8x6,2L	> 2.5	< 350	250 +/- 0	90	40
Ø 8~ 10,5 L	> 2.5	350 ~2000	240 +/- 0	90	30
Ø10~10,5 / 13,5L	> 2.5	350 ~2000	235 +/- 0	60	30
Ø12,5 & Ø 16	> 2.5	> 2000	230 +/- 0	30 (20)	20

Refer to table 4-2, 5-2 and Figure 5-1, IPC / JEDEC J-STD-020C

Re: (20)X is special for midh or high voltage V-Chip capacitors which is Serie H serie made by EDCON.

Classified at Temperature and Time Only for Standard Site without					
Size	Thickness/mm	Volume/mm <sup>3</sup>	Tp (°C)	tl / second	tp / second
Ø 4~ 6,3 & Ø 8x6,2L	> 2.5	< 350	260 +/- 0	90	5
Ø 8~ 10,5 L	> 2.5	350 ~2000	260 +/- 0	90	5
Ø10~10,5 / 13,5L	> 2.5	350 ~2000	260 +/- 0	60	5

- 1 Average ramp-up rate is 3°C/second max.
- 2 Ramp-down rate is 6°C/second max.
- 3 Time from 25°C to peak temperature is 8 minutes max.

### SMT Electrolytic Capacitor Serie SS

Serie No.: I15001

DRW:	Jason	CHKD	Wilson	MATL:	Wilson	TOLERANCE	Mason	DATE	12.02.2010
APPD:	Schumi			FINISH	Jamy		Sheet No.		7 from 10

Customer:

# EDCON-COMPONENTS



Designed for surface mounting on high density circuit board  
 Emboss carrier tape packing systems is available for automatic insertion.



## Application Guideline for CHIP Aluminium Electrolytic Capacitors

### 1. Circuit Design

- a. Please make sure the environmental and mounting conditions to which the capacitor will be exposed are within the conditions specified in EDCON catalogue.
- b. Operating temperature and applied ripple shall be within EDCON specification.
- c. Appropriate capacitors which comply with the life requirement of the products should be selected when designing the circuit.
- d. Aluminum electrolytic capacitors are polar. Make sure that no reverse voltage or AC voltage is applied to the capacitors. Please use bi-polar capacitors for a circuit that can possibly see reversed polarity. Even bi-polar capacitors cannot be used for AC Voltage application.
- e. Do not use aluminum electrolytic capacitors in a circuit that requires rapid and very frequent charge / discharge. In this type of circuit, it is necessary to use a special design capacitor with extended life characteristics.
- f. Do not apply excess voltage.

Please pay attention to that the peak voltage, which is DC voltage overlapped by ripple current, will not exceed the rated voltage.

In the case where more than 2 aluminum electrolytic capacitors are used in series, please make sure that applied voltage will be lower than rated voltage and the voltage will be applied to each capacitor equally by using a balancing resistor in parallel with the capacitor.

g. Aluminum electrolytic capacitors shall not be used under the following environmental conditions: Capacitors will be exposed to water (including condensation), brine or oil.

Ambient conditions that include toxic gases such as hydrogen sulfide, sulfurous acid, nitrous acid, chlorine, bromine, methyl bromide, ammonium, etc.

Ambient conditions that expose the capacitor to ozone, ultraviolet ray and radiation.

Severe vibration and physical shock conditions that exceed KJ specification.

Vibration test condition:	vibration frequency range	10~55~10Hz
	sweep rate	10~55~10Hz/minute
	sweep method	logarithmic
	amplitude or acceleration	1.5mm (max. acceleration is 10G)
	direction of vibration	X, Y, Z direction
	testing time	2 hours per each direction

DRW:	Jason	CHKD	Wilson	MATL:	Wilson	TOLERANCE	Mason	DATE	12.02.2010
APPD:	Schumi			FINISH	Jamy		Sheet No.	8 from 10	

Shock is not applicable normally.

If a particular condition is required, please contact our sales office.

The main chemical solution of the electrolyte and the separator paper used in the capacitors are combustible. The electrolyte is conductive. When it comes in contact with the PC board, there is a possibility of pattern corrosion or short circuit between the circuit pattern, which could result in smoking or catching fire. Do not locate any circuit pattern beneath the capacitor end seal.

Do not design a circuit board that the heat generating components are placed near the aluminum electrolytic capacitor or on the reverse side of PC board, if that just under the capacitor.

Please refer to the table of land size(mm) below when you design in surface mount capacitors.

Electrical characteristics may vary depending on changes in temperature and frequency. Please consider this variation when you design circuits.

When you install more than 2 capacitors in parallel, please consider the balance of current flowing into the capacitors.

While mounting capacitors on double-side PC board, the capacitors should be away from those unnecessary base plate holes and connection holes.

Cap Size	a	b	c
Ø4	1,0	2,6	1,6
Ø5	1,4	3,0	1,6
Ø6,3L	2,1	3,5	1,6
Ø8x6,2L	2,1	4,0	1,6
Ø8x10,5L	3,0	3,5	2,5
Ø10	4,0	4,0	2,5
Ø12,5	4,0	5,7	3,0
Ø16	6,0	6,5	3,5



<b>SMT Electrolytic Capacitor Serie SS</b>	
Serie No.:	<b>I15001</b>
Customer:	



# EDCON-COMPONENTS



Designed for surface mounting on high density circuit board

Emboss carrier tape packing systems is available for automatic insertion.



## Application Guideline for CHIP Aluminium Electrolytic Capacitors

### 2. Mounting

Once a capacitor has been assembled in the set and power applied, do not attempt to re-use the capacitor in other circuits or application.

Leakage current of the capacitors that have been stored for more than 2 years may increase. When leakage current has increased, please perform a voltage treatment using a 1k $\Omega$  resistor.

Please confirm specifications and polarity before installing capacitors on the PC board.

Do not drop capacitors on the floor, nor use a capacitor that was dropped.

Do not deform the capacitor during installation.

Please pay attention to the mechanical shock to the capacitor by suction nozzle of the automatic insertion machine or automatic mounter, or by product checker, or by centering mechanism.

#### Reflow soldering

Please follow "Reflow Soldering Conditions" in EDCON's catalogue.

When an infrared heater is used, please pay attention to the extent of heating since the absorption rate of infrared will vary due to difference in the color and size of the capacitor.

Do not tilt lay down or twist the capacitor body after the capacitor are soldered to the PC board.

Do not carry the PC board by grasping the soldered capacitor.

Please do not allow anything to touch the capacitor after soldering. If PC boards are stored in stack, please make sure the PC board or other components away from the capacitor.

The capacitors shall not be effected by any radiated heat from the soldered PC board or other components after soldering.

#### Cleaning

Do not clean capacitors with halogenated cleaning agent. However, if it is necessary to clean with halogenated cleaning agent, please contact our sales office.

#### Recommended cleaning method

Applicable

Any type, any ratings

Cleaning agents

Pine Alpha ST-100S, Clean Through 750H/750L/710M, Sanelek B-12, Aqua Cleaner 210SEP, Techno Care FRW14~17, Isopropyl Alcohol.

Cleaning conditions

Total cleaning time shall be within 2 minutes by immersion, ultrasonic or other methods. Temperature of the cleaning agents shall be 40°C or below. After cleaning, capacitors should be dried by using hot air for the minimum 10 minutes along with the PC board mounted. Hot air temperature should be within the maximum operating temperature of the capacitor. Insufficient dryness after water rinse may cause appearance problems, such as bottom-plate bulge and etc.

Avoid using ozone destructive substances as cleaning agents for protecting global environment.

Please consult us regarding other cleaning agents or cleaning methods.

### 3. In the Equipment

Do not directly touch terminal by hand.

Do not link positive terminal and negative terminal by conductor, nor spill conductible liquid such as alkaline or acidic solution on or near the capacitor.

Please make sure that the ambient conditions where the set is installed are free from spilling water or oil, direct sunlight, ultraviolet rays, radiation, poisonous gases, vibration or mechanical shock.

**SMT Electrolytic Capacitor**  
**Serie SS**

Serie No.: **I15001**

DRW:	Jason	CHKD	Wilson	MATL:	Wilson	TOLERANCE	Mason	DATE	12.02.2010
APPD:	Schumi			FINISH	Jamy		Sheet No.		9 from 10

Customer:

# EDCON-COMPONENTS



Designed for surface mounting on high density circuit board

Emboss carrier tape packing systems is available for automatic insertion.



## Application Guideline for CHIP Aluminium Electrolytic Capacitors

### 4. Maintenance and Inspection

Please periodically inspect the aluminum capacitors that are installed in industrial equipment. The following items should be checked:

Appearance: remarkable abnormality such as pressure relief vent opening, electrolyte leaking, etc.

Electrical characteristics: capacitance, dielectric loss tangent, leakage current and etc., which are specified in KJ's catalogue or alternate product specification.

### 5. In an Emergency

If you see smoke due to operation of safety vent, please turn off the main switch or pull out the plug from the outlet.

If you breathe the gas or ingest the electrolyte, please wash out your mouth and throat with water immediately.

If your skin is exposed to the electrolyte, please wash it away using soap and water.

### 6. Storage

Do not keep capacitor in high temperature and high humidity atmosphere.

Storage conditions should be:

Temperature : 5°C~35°C  
 Humidity : lower than 75%  
 Place : Indoor

Avoid ambient conditions where capacitors are covered with water, brine or oil.

Avoid ambient conditions where capacitors are permeated by poisonous gases such as hydrogen sulfide, sulfurous acid, nitrous acid, chlorine, bromine, methyl bromide, ammonium and etc.

Avoid ambient conditions where capacitors are exposed to ozone, ultraviolet ray or radiation.

### 7. Disposal

Please take either of the following methods in disposing capacitors.

Incinerate them after crushing capacitors or making a hole on the capacitor body.

If incineration is not applicable, hand them over to a waste disposal agent and have them buried in landfills.

**SMT Electrolytic Capacitor  
Serie SS**

Serie No.: I15001

DRW:	Jason	CHKD	Wilson	MATL:	Wilson	TOLERANCE	Mason	DATE	12.02.2010
APPD:	Schumi			FINISH	Jamy		Sheet No.		10 from 10

Customer: