

EDCON-COMPONENTS

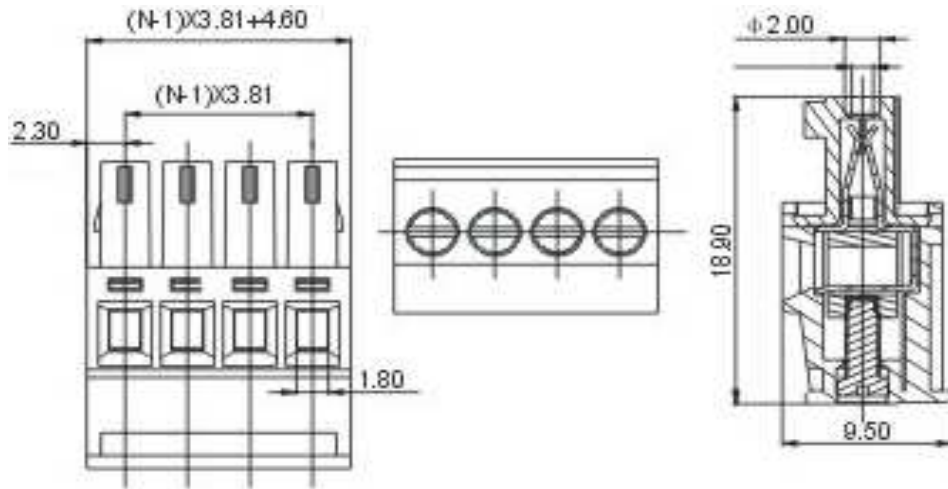

Drawing



P.C.B. Layout

Specification

APPROVAL



Electrical

Standard
Rated voltage
Rated current
Wire range
Withstanding voltage

UL	IEC
300V	250V
8A	7A
28-16 AWG	0.5-1.5mm ²
AC 2000V/1min	

Mechanical

Ambient temperature
Strip length
Screw, Torque

-30°C ~ +120°C
7mm
M2, 0.2Nm (1.7Lb-In.)

Dimensions

Pitch
Poles

3.81mm
2P - 20P

Material

Housing
Pin header
Screws
Cage

PBT (UL94V-0)
Phosphor Bronze
Steel, Cr³⁺ Zn plated
Brass, Ni plated



Certification



Pluggable Terminal Block /
Pitch 3.81mm

Part No.: A14H045

Customer:

DRW:	Justin	CHKD	Frank	MATL:	Jordan	TOLERANCE	Lord	Date	10.02.2009
APPD:	Pete			FINISH	Mike			Sheet No.	1 from 3

www.edcon-components.com

email: info@edcon-components.com

EDCON-COMPONENTS



Ordering Informations

Serie	-	No. of Pole	Body-Color	-	Customer Request
-------	---	-------------	------------	---	------------------

A14H045	-	XX	XX	-	X
		XX = total	WH - white		
		02	GN - green		
		...	GR - gray		
		20	TP - transparent		
			OR - orange		
			BK - black		
			BL - blue		
			RD - red		
			YW - yellow		
			PG - Phoenix Green		



Certification



Pluggable Terminal Block / Pitch 3.81mm	
Part No.:	A14H045
Customer:	

DRW:	Justin	CHKD	Frank	MATL:	Jordan	TOLERANCE	Lord	Date	10.02.2009
APPD:	Pete			FINISH	Mike			Sheet No.	2 from 3

www.edcon-components.com

email: info@edcon-components.com



Soldering - Profil

Classification Reflow Profile (JEDEC J-STD-020C)

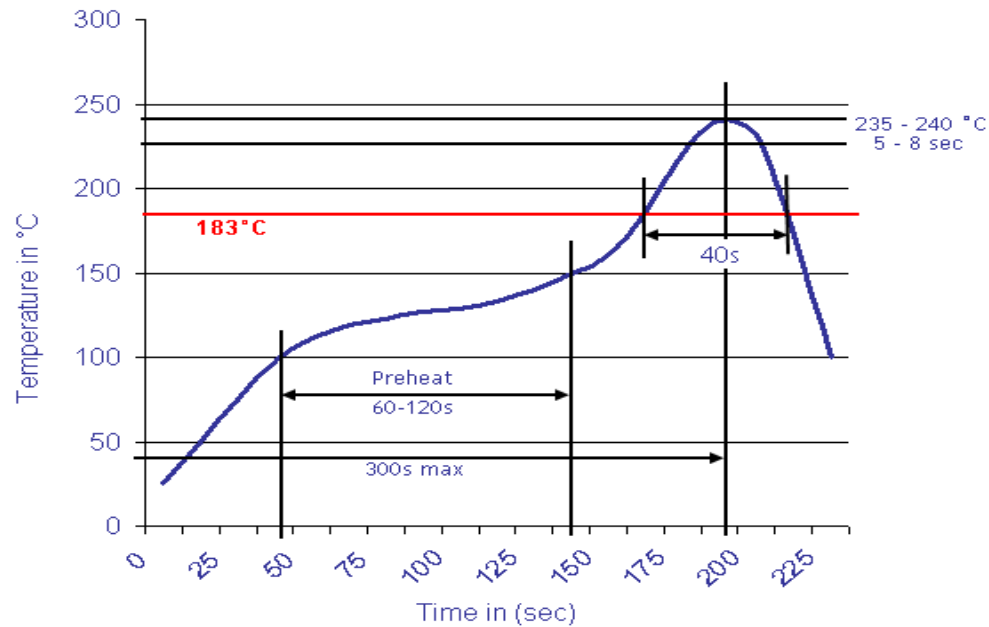

Pluggable Terminal Block /
Pitch 3.81mm

Part No.: A14H045

Customer:

DRW:	Justin	CHKD	Frank	MATL:	Jordan	TOLERANCE	Lord	Date	10.02.2009
APPD:	Pete			FINISH	Mike		Sheet No.		3 from 3