

# EDCON-COMPONENTS

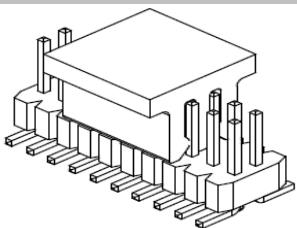

## Specifications

Current Rating:	1 Ampere
Insulator Resistance:	5000 Megaohm min.
Dielectric Withstanding:	AC 500V
Operating Temperature:	.-40°C to +105°C
Contact Material:	Copper, Alloy
Insulator Material:	Thermoplastic, UL 94V-0
Standard:	Nylon 6T
Contact Plating:	Tin, Gold or Selective Plated
Standard:	Gold Flash Overall
Selectiv Plating:	Gold flash plated on contact area / tin plated on solder area
Max. Processing Temp.	230°C for 60 seconds

## P.C.B Layout

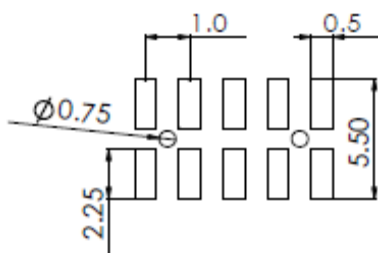

## Drawing ( dimensions all into mm)

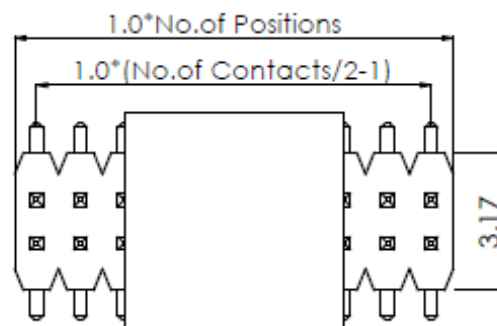
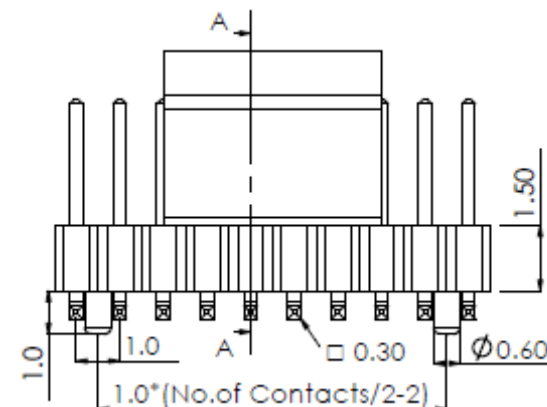
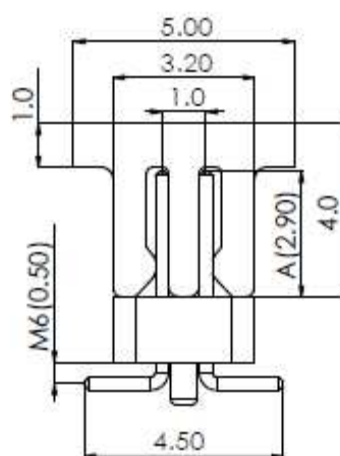

PIN Header / Dual Row / Single  
Body / Pitch 1,00mm

Part No.: **T51D1002**

Customer:

DRW:	Jason	CHKD	Wilson	MATL:	Wilson	TOLERANCE	Mason	DATE	06.01.2009
APPD:	Schumi			FINISH	Jamy		Sheet No.	1 from 4	

# EDCON-COMPONENTS

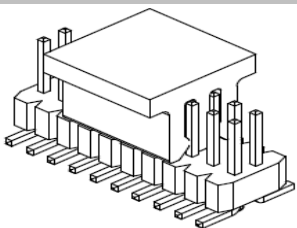

## Pin Code length table free configuration

Order Code	Dimension (mm)		
	A	M6	
A01	2,90	0,50	
A02			
A03			
A04			
A05			
A06			
A07			
A08			
A09			
A10			
A11			
A12			
A13			
A14			
A15			
A16			
A17			
A18			
A19			
A20			
A21			
A22			

Order Code	Dimension (mm)		
	A	M6	
A23			
A24			
A25			
A26			
A27			
A28			
A29			
A30			
A31			
A32			
A33			
A34			
A35			
A36			
A37			
A38			
A39			
A40			
A41			
A42			
A43			
A44			

Order Code	Dimension (mm)		
	A	M6	
A45			
A46			
A47			
A48			
A49			
A50			
A51			
A52			
A53			
A54			
A55			
A56			
A57			
A58			
A59			
A60			
A61			
A62			
A63			
A64			
A65			
A66			

PIN Header / Dual Row / Single Body / Pitch 1,00mm

Part No.: **T51D1002**

DRW:	Jason	CHKD	Wilson	MATL:	Wilson	TOLERANCE	Mason	DATE	06.01.2009
APPD:	Schumi			FINISH	Jamy		Sheet No.		2 from 4

Customer:

# EDCON-COMPONENTS

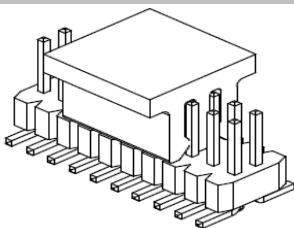

## Ordering Informations

Serie	No. of Pos.	Construction	Contact Plating	Material	Polarisation Peg	Pin Length Code	ROHS	Packing		
<b>T51D1002</b>	<b>XX</b>	<b>SS</b>	<b>G0</b>	<b>NY</b>	<b>Y</b>	<b>A01</b>	<b>R</b>	<b>BU</b>		

<b>XX</b> = total pin of header	<b>SS</b> = straight SMT	<b>G0</b> = Gold Flash (Standard)	<b>PB</b> =P.B.T (Standard)	<b>Y</b> = Yes	look table page 2	<b>N</b> =NO ROHS conform	<b>BU</b> = Bulk (Standard)
		<b>T0</b> = Tin plated	<b>PY</b> = Polyester UL94V-0			<b>R</b> =ROHS conform	<b>TU</b> = Tube w/o Cap
		<b>GA</b> = 10µ Gold Plating	<b>NY</b> = Nylon-6T				<b>TC</b> = Tube w. pic and Place Cap
		<b>GB</b> = 15µ Gold Plating					<b>TY</b> = Tray packing w/o Cap
		<b>GC</b> = 20µ Gold Plating					<b>TR</b> = Tape/Reel w. pic and Place Cap
		<b>S0</b> = Selectiv Plating Gold Flash / Tin					
		<b>TN</b> = Tin Plated					

PIN Header / Dual Row / Single Body / Pitch 1,00mm

Part No.: **T51D1002**

DRW:	Jason	CHKD	Wilson	MATL:	Wilson	TOLERANCE	Mason	DATE	06.01.2009
APPD:	Schumi			FINISH	Jamy		Sheet No.		3 from 4

Customer:

# EDCON-COMPONENTS

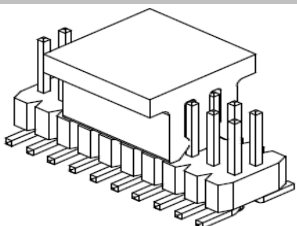

## Soldering Profile for Lead Soldering ( P.B.T. )



## Soldering Profile for Lead Free Soldering ( Nylon 6T )



PIN Header / Dual Row / Single Body / Pitch 1,00mm

Part No.: **T51D1002**

Customer:

DRW:	Jason	CHKD	Wilson	MATL:	Wilson	TOLERANCE	Mason	DATE	06.01.2009
APPD:	Schumi			FINISH	Jamy		Sheet No.	4 from 4	

[www.edcon-components.com](http://www.edcon-components.com)

email: [info@edcon-components.com](mailto:info@edcon-components.com)