

EDCON-COMPONENTS

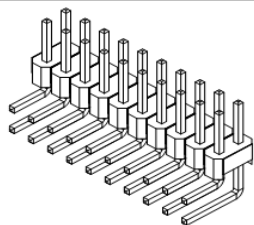

Specifications

| | |
|--------------------------|--|
| Current Rating: | 1 Ampere |
| Insulator Resistance: | 5000 Megaohm min. |
| Dielectric Withstanding: | AC 1000V |
| Operating Temperature: | .-40°C to +105°C |
| Contact Material: | Copper, Alloy |
| Insulator Material: | Polyester, UL 94V-0 |
| Standard: | P.B.T. |
| Contact Plating: | Tin, Gold or Selective Plated |
| Standard: | Gold Flash Overall |
| Selectiv Plating: | Gold flash plated on contact area / tin plated on solder area |
| Max. Processing Temp. | 230°C for 60 seconds |

P.C.B Layout

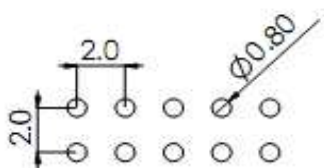

Drawing (dimensions all into mm)

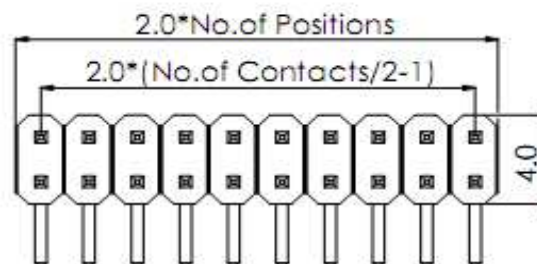
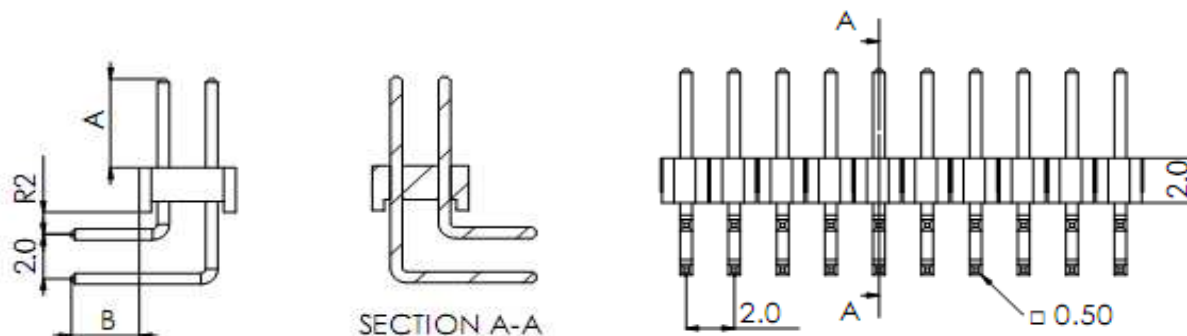

PIN Header / Dual Row / Single
Body / Pitch 2,00mm

Part No.: **T51B1008**

Customer:

| | | | | | | | | | |
|-------|--------|------|--------|--------|--------|-----------|-----------|----------|------------|
| DRW: | Jason | CHKD | Wilson | MATL: | Wilson | TOLERANCE | Mason | DATE | 06.01.2009 |
| APPD: | Schumi | | | FINISH | Jamy | | Sheet No. | 1 from 4 | |

EDCON-COMPONENTS

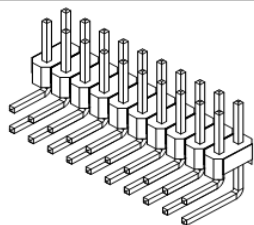

Pin Code length table free configuration

| Order Code | Dimension (mm) | | |
|------------|----------------|------|------|
| | A | B | R2 |
| A01 | 4,00 | 2,80 | 1,00 |
| A02 | 3,20 | 3,00 | 1,27 |
| A03 | 3,20 | 3,00 | 1,75 |
| A04 | 5,00 | 3,00 | 1,75 |
| A05 | | | |
| A06 | | | |
| A07 | | | |
| A08 | | | |
| A09 | | | |
| A10 | | | |
| A11 | | | |
| A12 | | | |
| A13 | | | |
| A14 | | | |
| A15 | | | |
| A16 | | | |
| A17 | | | |
| A18 | | | |
| A19 | | | |
| A20 | | | |
| A21 | | | |
| A22 | | | |

| Order Code | Dimension (mm) | | |
|------------|----------------|---|----|
| | A | B | R2 |
| A23 | | | |
| A24 | | | |
| A25 | | | |
| A26 | | | |
| A27 | | | |
| A28 | | | |
| A29 | | | |
| A30 | | | |
| A31 | | | |
| A32 | | | |
| A33 | | | |
| A34 | | | |
| A35 | | | |
| A36 | | | |
| A37 | | | |
| A38 | | | |
| A39 | | | |
| A40 | | | |
| A41 | | | |
| A42 | | | |
| A43 | | | |
| A44 | | | |

| Order Code | Dimension (mm) | | |
|------------|----------------|---|----|
| | A | B | R2 |
| A45 | | | |
| A46 | | | |
| A47 | | | |
| A48 | | | |
| A49 | | | |
| A50 | | | |
| A51 | | | |
| A52 | | | |
| A53 | | | |
| A54 | | | |
| A55 | | | |
| A56 | | | |
| A57 | | | |
| A58 | | | |
| A59 | | | |
| A60 | | | |
| A61 | | | |
| A62 | | | |
| A63 | | | |
| A64 | | | |
| A65 | | | |
| A66 | | | |

PIN Header / Dual Row / Single Body / Pitch 2,00mm

Part No.: **T51B1008**

Customer:

| | | | | | | | | | |
|-------|--------|------|--------|--------|--------|-----------|-----------|------|------------|
| DRW: | Jason | CHKD | Wilson | MATL: | Wilson | TOLERANCE | Mason | DATE | 06.01.2009 |
| APPD: | Schumi | | | FINISH | Jamy | | Sheet No. | | 2 from 4 |

EDCON-COMPONENTS

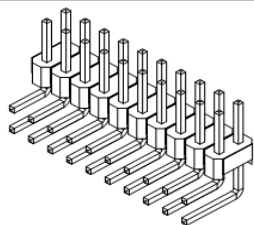

Ordering Informations

| Serie | No. of Pos. | Construction | Contact Plating | Material | Polarisation Peg | Pin Length Code | ROHS | Packing | | |
|-----------------|-------------|--------------|-----------------|-----------|------------------|-----------------|----------|-----------|--|--|
| T51B1008 | XX | RT | G0 | PB | N | A01 | R | BU | | |

| | | | | | | | |
|---------------------------------|-----------------------------|---|-------------------------------|---------------|-------------------|---------------------------|--|
| XX = total pin of header | RT = right angle THT | G0 = Gold Flash (Standard) | PB =P.B.T (Standard) | N = No | look table page 2 | N =NO ROHS conform | BU = Bulk (Standard) |
| | | T0 = Tin plated | PY = Polyester UL94V-0 | | | R =ROHS conform | TU = Tube w/o Cap |
| | | GA = 10µ Gold Plating | NY = Nylon-6T | | | | TC = Tube w. pic and Place Cap |
| | | GB = 15µ Gold Plating | | | | | TY = Tray packing w/o Cap |
| | | GC = 20µ Gold Plating | | | | | TR = Tape/Reel w. pic and Place Cap |
| | | S0 = Selectiv Plating Gold Flash / Tin | | | | | |
| | | TN = Tin Plated | | | | | |

PIN Header / Dual Row / Single Body / Pitch 2,00mm

Part No.: **T51B1008**

| | | | | | | | | | |
|-------|--------|------|--------|--------|--------|-----------|-----------|------|------------|
| DRW: | Jason | CHKD | Wilson | MATL: | Wilson | TOLERANCE | Mason | DATE | 06.01.2009 |
| APPD: | Schumi | | | FINISH | Jamy | | Sheet No. | | 3 from 4 |

Customer:

EDCON-COMPONENTS

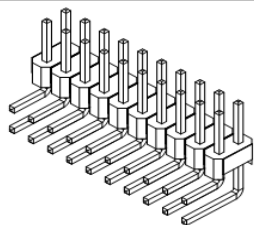

Soldering Profile for Lead Soldering (P.B.T.)



Soldering Profile for Lead Free Soldering (Nylon 6T)



PIN Header / Dual Row / Single Body / Pitch 2,00mm

Part No.: **T51B1008**

| | | | | | | | | | |
|-------|--------|------|--------|--------|--------|-----------|-----------|----------|------------|
| DRW: | Jason | CHKD | Wilson | MATL: | Wilson | TOLERANCE | Mason | DATE | 06.01.2009 |
| APPD: | Schumi | | | FINISH | Jamy | | Sheet No. | 4 from 4 | Customer: |

www.edcon-components.com

email: info@edcon-components.com