

EDCON-COMPONENTS

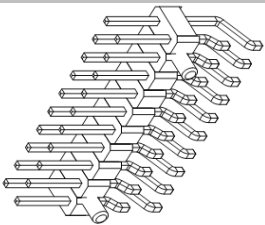

Specifications

Current Rating:	3 Ampere
Insulator Resistance:	5000 Megaohm min.
Dielectric Withstanding:	AC 1000V
Operating Temperature:	-.40°C to +105°C
Contact Material:	Copper, Alloy
Insulator Material:	Polyester, UL 94V-0
Standard:	P.B.T.
Contact Plating:	Tin, Gold or Selective Plated
Standard:	Gold Flash Overall
Selectiv Plating:	Gold flash plated on contact area / tin plated on solder area
Max. Prozessing Temp.	230°C for 60 seconds

P.C.B Layout

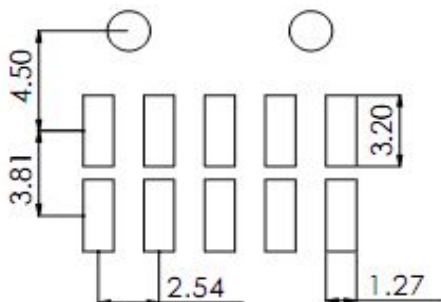

Drawing (dimensions all into mm)

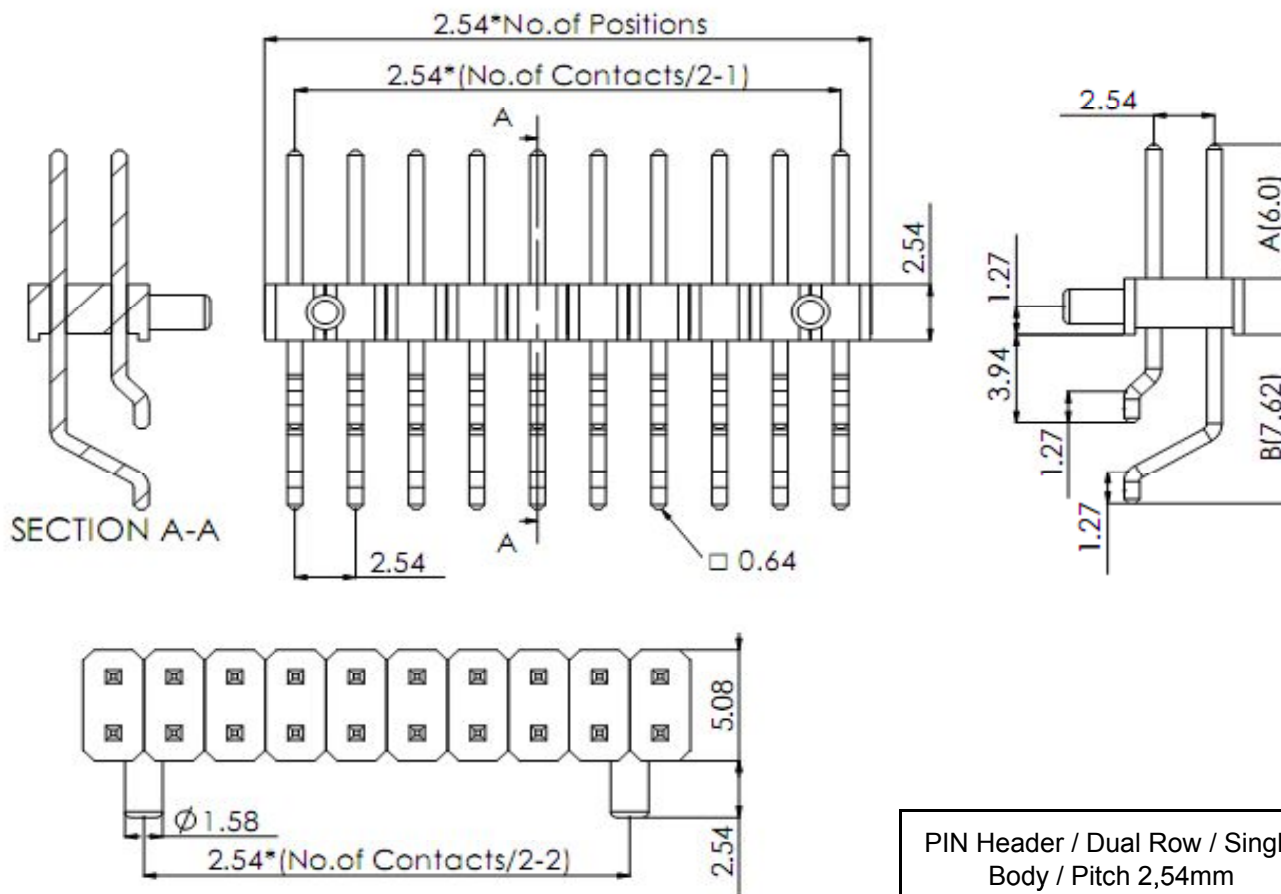

PIN Header / Dual Row / Single Body / Pitch 2,54mm	
Part No.:	T51A1037-
Customer:	

DRW:	Jason	CHKD	Wilson	MATL:	Wilson	TOLERANCE	Mason	DATE	21.04.2023
APPD:	Schumi			FINISH	Jamy		Sheet No.		1 from 4

EDCON-COMPONENTS

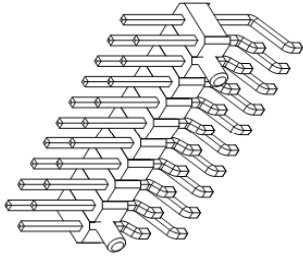

Pin Code length table free configuration

Order Code	Dimension (mm)			
	A	B		
A01	6,00	7,60		
A02	5,84	7,62		
A03	6,50	7,60		
A04	7,00	7,60		
A05	7,50	7,60		
A06	8,00	7,60		
A07	8,50	7,60		
A08	9,00	7,60		
A09	10,00	7,60		
A10				
A11				
A12				
A13				
A14				
A15				
A16				
A17				
A18				
A19				
A20				
A21				
A22				

Order Code	Dimension (mm)			
	A	B		
A23				
A24				
A25				
A26				
A27				
A28				
A29				
A30				
A31				
A32				
A33				
A34				
A35				
A36				
A37				
A38				
A39				
A40				
A41				
A42				
A43				
A44				

Order Code	Dimension (mm)			
	A	B		
A45				
A46				
A47				
A48				
A49				
A50				
A51				
A52				
A53				
A54				
A55				
A56				
A57				
A58				
A59				
A60				
A61				
A62				
A63				
A64				
A65				
A66				

PIN Header / Dual Row / Single Body / Pitch 2,54mm

Part No.: **T51A1037-**

DRW:	Jason	CHKD	Wilson	MATL:	Wilson	TOLERANCE	Mason	DATE	21.04.2023
APPD:	Schumi			FINISH	Jamy		Sheet No.		2 from 4

Customer:

EDCON-COMPONENTS

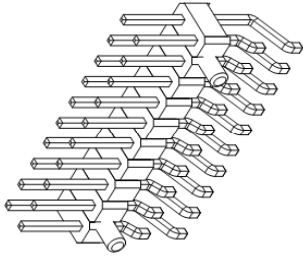

Ordering Informations

Serie	No. of Pos.	Construction	Contact Plating	Material	Polarisation Peg	Pin Length Code	ROHS	Packing		
T51A1037-	XX	RS	G0	PB	Y	A01	R	BU		

XX = total pin of header	RS = right angle SMT	G0 = Gold Flash (Standard)	PB =P.B.T (Standard)	Y = With	look table page 2	N =NO ROHS	BU = Bulk (Standard)
T0 = Tin plated	GA = 10µ Gold Plating	PY = Polyester UL94V-0	R =ROHS conform			TU = Tube w/o Cap	
GB = 15µ Gold Plating	GC = 20µ Gold Plating	NY = Nylon-6T	TC = Tube w. pic and Place Cap				
S0 = Selectiv Plating Gold Flash / Tin	TN = Tin Plated		TY = Tray packing w/o Cap				
			TR = Tape/Reel w. pic and Place Cap				

PIN Header / Dual Row / Single Body / Pitch 2,54mm
Part No.: T51A1037-
Customer:

DRW:	Jason	CHKD	Wilson	MATL:	Wilson	TOLERANCE	Mason	DATE	21.04.2023
APPD:	Schumi			FINISH	Jamy		Sheet No.		3 from 4

www.edcon-components.com

email: info@edcon-components.com

EDCON-COMPONENTS

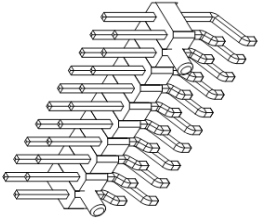

Soldering Profile for Lead Soldering (P.B.T.)

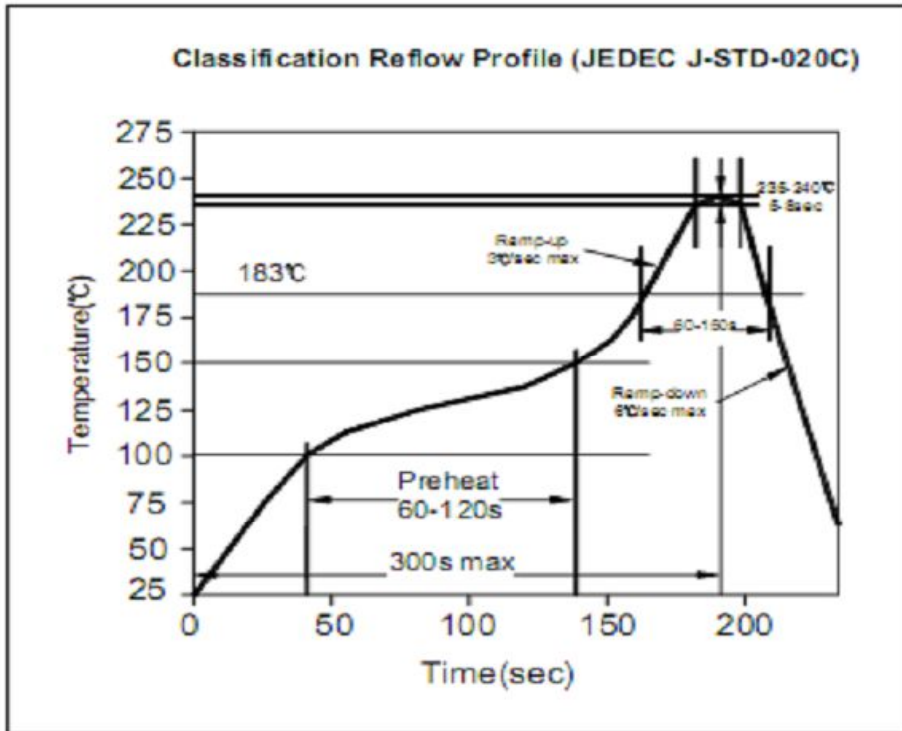

Soldering Profile for Lead Free Soldering (Nylon 6T)

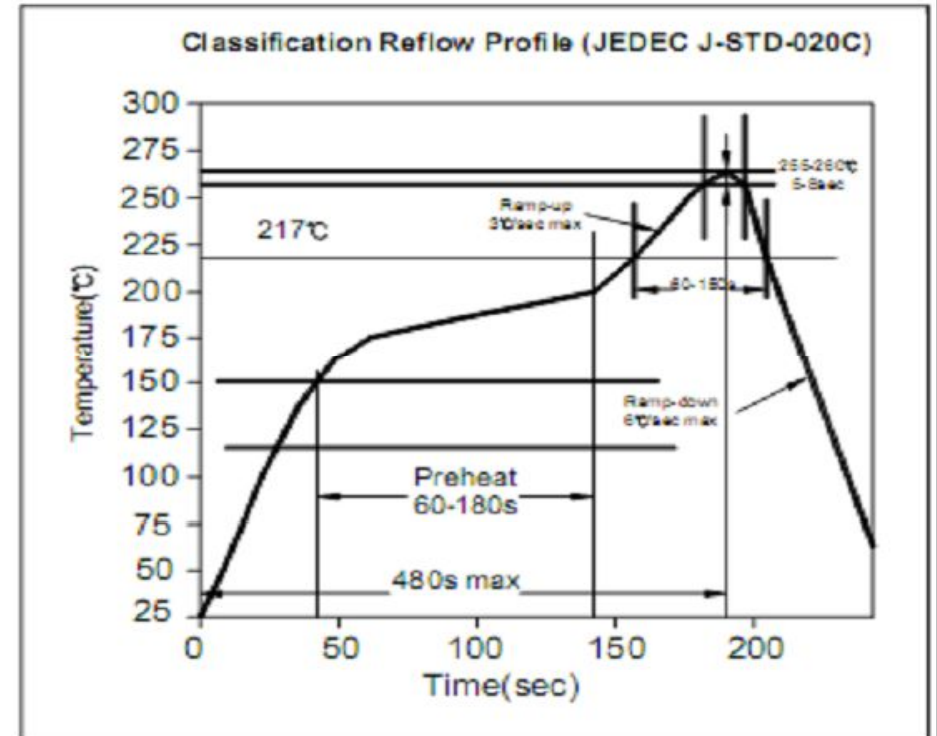

PIN Header / Dual Row / Single Body / Pitch 2,54mm

Part No.: **T51A1037-**

DRW:	Jason	CHKD	Wilson	MATL:	Wilson	TOLERANCE	Mason	DATE	21.04.2023
APPD:	Schumi			FINISH	Jamy		Sheet No.	4 from 4	Customer:

www.edcon-components.com

email: info@edcon-components.com