

EDCON-COMPONENTS

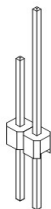

Specifications

Current Rating:	3 Ampere
Insulator Resistance:	5000 Megaohm min.
Dielectric Withstanding:	AC 1000V
Operating Temperature:	.-40°C to +105°C
Contact Material:	Copper, Alloy
Insulator Material:	Polyester, UL 94V-0
Standard:	P.B.T.
Contact Plating:	Tin, Gold or Selective Plated
Standard:	Gold Flash Overall
Selectiv Plating:	Gold flash plated on contact area / tin plated on solder area
Max. Processing Temp.	230°C for 60 seconds

P.C.B Layout

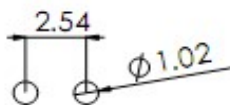

Drawing (dimensions all into mm)

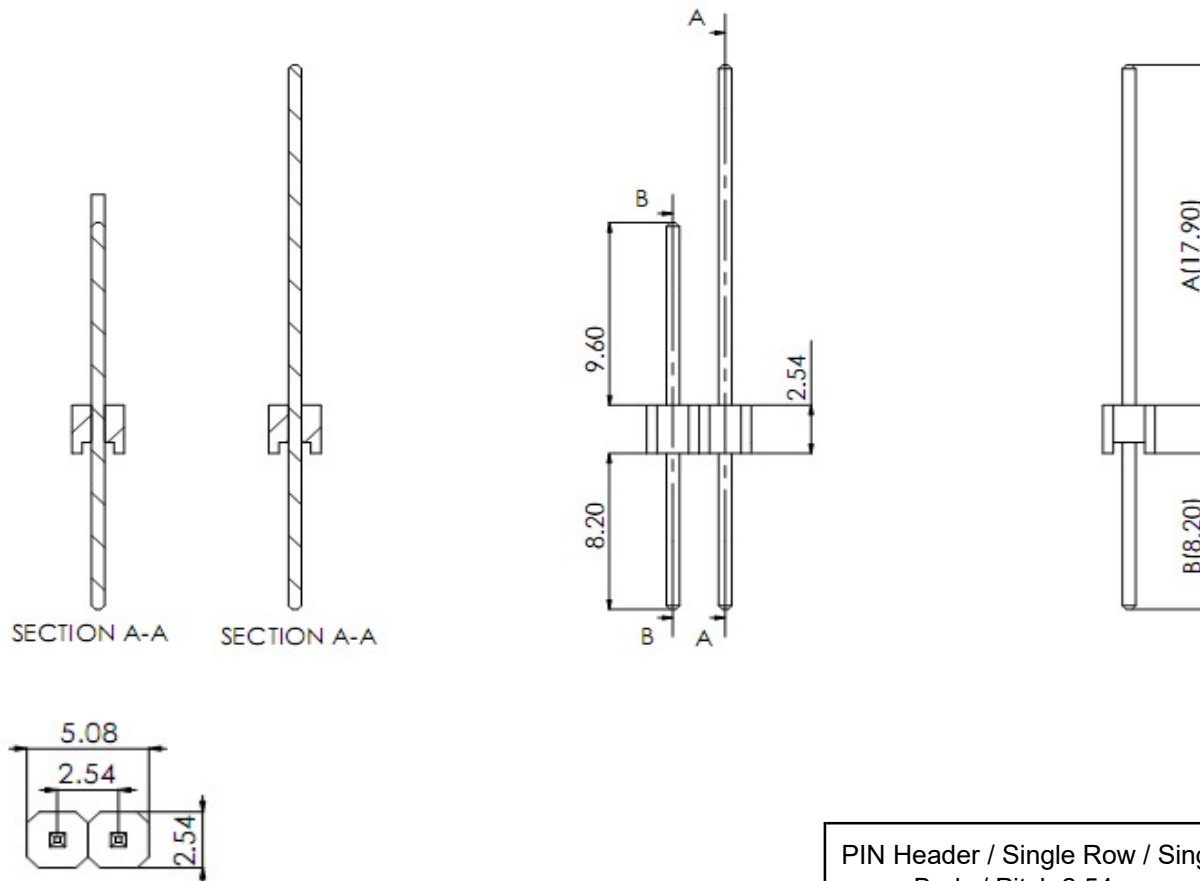

PIN Header / Single Row / Single Body / Pitch 2,54mm

Part No.: **T51A1028 -**

DRW:	Jason	CHKD	Wilson	MATL:	Wilson	TOLERANCE	Mason	DATE	03.03.2023	Customer:
APPD:	Schumi			FINISH	Jamy		Sheet No.	1 from 4		

www.edcon-components.com

email: info@edcon-components.com

EDCON-COMPONENTS

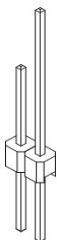

Pin Code length table free configuration

Order Code	Dimension (mm)		
	A	B	
A01	17,90	8,20	
A02			
A03			
A04			
A05			
A06			
A07			
A08			
A09			
A10			
A11			
A12			
A13			
A14			
A15			
A16			
A17			
A18			
A19			
A20			
A21			
A22			

Order Code	Dimension (mm)		
	A	B	
A23			
A24			
A25			
A26			
A27			
A28			
A29			
A30			
A31			
A32			
A33			
A34			
A35			
A36			
A37			
A38			
A39			
A40			
A41			
A42			
A43			
A44			

Order Code	Dimension (mm)		
	A	B	
A45			
A46			
A47			
A48			
A49			
A50			
A51			
A52			
A53			
A54			
A55			
A56			
A57			
A58			
A59			
A60			
A61			
A62			
A63			
A64			
A65			
A66			

PIN Header / Single Row / Single Body / Pitch 2,54mm

Part No.: **T51A1028 -**

DRW:	Jason	CHKD	Wilson	MATL:	Wilson	TOLERANCE	Mason	DATE	03.03.2023
APPD:	Schumi			FINISH	Jamy		Sheet No.		2 from 4

Customer:

EDCON-COMPONENTS

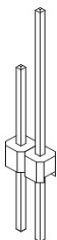

Ordering Informations

Serie	No. of Pos.	Construction	Contact Plating	Material	Polarisation Peg	Pin Length Code	ROHS	Packing		
T51A1028 -	XX	ST	G0	PB	N	Axx	R	BU		

XX = total pin of header	ST = Straight THT	G0 = Gold Flash (Standard)	PB =P.B.T (Standard)	N = No	look table page 2	N =NO ROHS conform	BU = Bulk (Standard)
T0 = Tin plated	GA = 10µ Gold Plating	PY = Polyester UL94V-0	R =ROHS conform			TU = Tube w/o Cap	
GB = 15µ Gold Plating	GC = 20µ Gold Plating	NY = Nylon-6T				TC = Tube w. pic and Place Cap	
S0 = Selectiv Plating Gold Flash / Tin						TY = Tray packing w/o Cap	
TN = Tin Plated						TR = Tape/Reel w. pic and Place Cap	

PIN Header / Single Row / Single Body / Pitch 2,54mm

Part No.: **T51A1028 -**

DRW:	Jason	CHKD	Wilson	MATL:	Wilson	TOLERANCE	Mason	DATE	03.03.2023	Customer:
APPD:	Schumi			FINISH	Jamy		Sheet No.		3 from 4	

www.edcon-components.com

email: info@edcon-components.com

EDCON-COMPONENTS

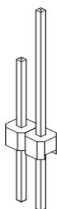

Soldering Profile for Lead Soldering (P.B.T.)

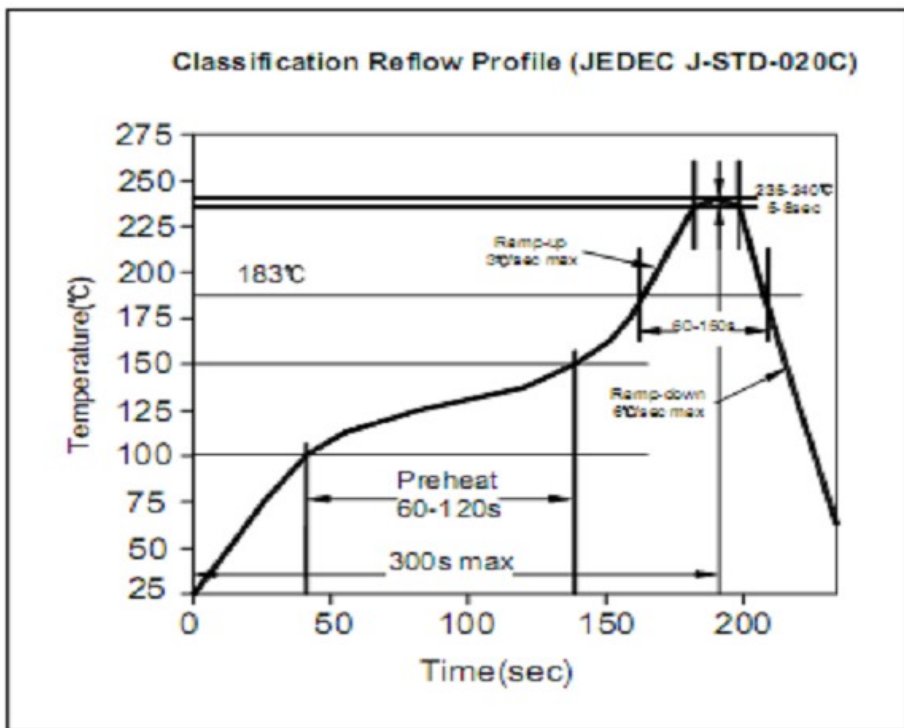

Soldering Profile for Lead Free Soldering (Nylon 6T)

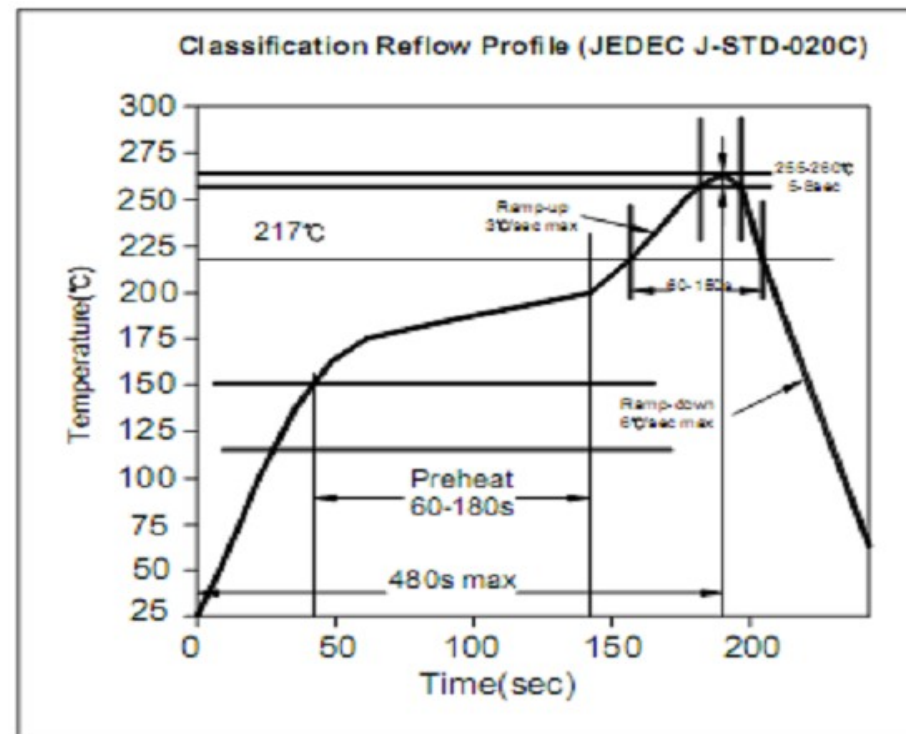

PIN Header / Single Row / Single Body / Pitch 2,54mm

Part No.: **T51A1028 -**

DRW:	Jason	CHKD	Wilson	MATL:	Wilson	TOLERANCE	Mason	DATE	03.03.2023	Customer:
APPD:	Schumi			FINISH	Jamy		Sheet No.	4 from 4		

www.edcon-components.com

email: info@edcon-components.com