

EDCON-COMPONENTS



Technical Discription

Standard:	IEC 60127, GB 9364
Operating Temperature:	. -55°C ~ + 125°C
Storage Temperature:	. -55°C ~ + 85°C
Solderability:	245°C ± 5°C 5sec ± 0,5sec
Resistance to Soldering Head:	260°C, 10s. Max.
Electrical Characteristics:	
2,1In	Max. 2 minutes
2,75In	Min 400ms
	Max. 10 seconds
4In	Min. 150ms
	Max. 3 seconds
10In	Min. 20ms
	Max. 150ms
Interrupting Capacity	
CCC/ CQC /SEMKO / VDE / UR / BSI	35A or 10In 250VAC wichever is greater
PSE 100A 250 VAC	
Range Code:	0A500
Range:	0A500= 500mA

Drawing (mm)

Short Lead

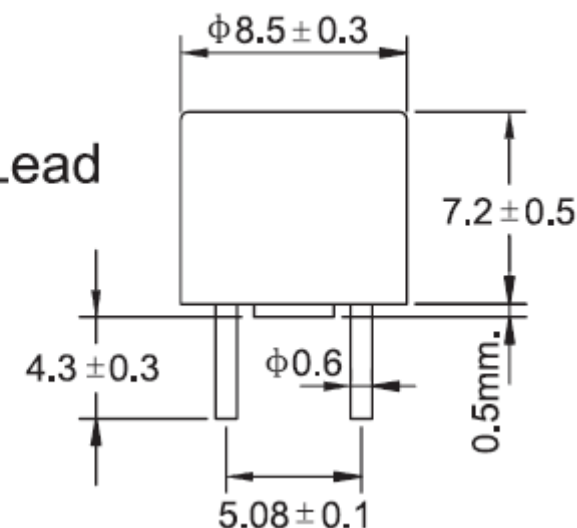

TAPE-Box-Packing

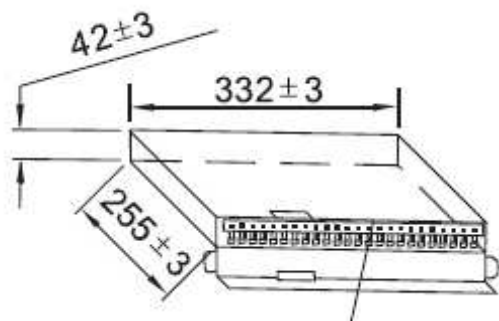

Approvals 250VAC

CCC	YES
CQC	
SEMKO	YES
VDE	YES
URus	YES
BSI	YES
PSE	
KC	YES

**8,5mm Round Fuse
Time Lag**

Part No.: **R25004**

DRW:	Jason	CHKD	Wilson	MATL:	Wilson	TOLERANCE	Mason	DATE	11.05.2014
APPD:	Schumi			FINISH	Jamy		Sheet No.		1 from 4

Customer:

EDCON-COMPONENTS



Current Characteristics Curve

Tape/Box Packing

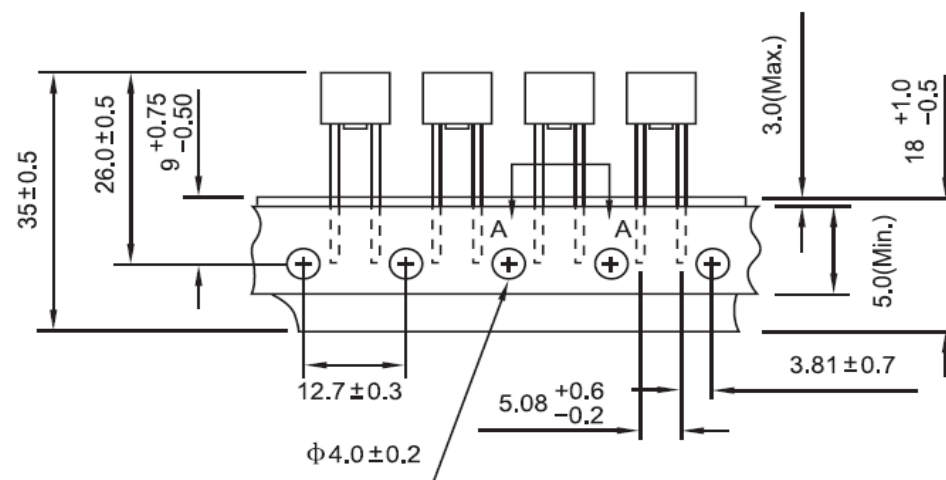
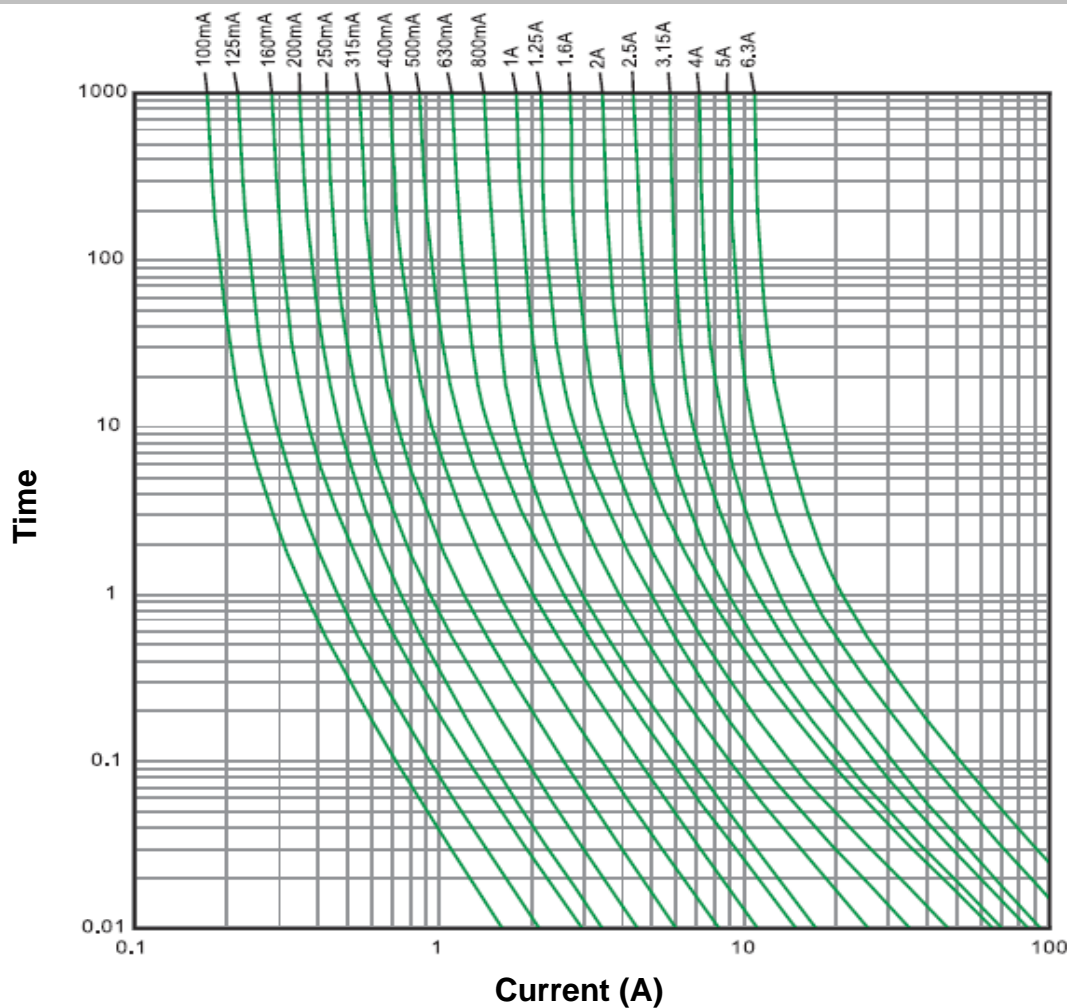

**8,5mm Round Fuse
Time Lag**

Part No.: **R25004**

DRW:	Jason	CHKD	Wilson	MATL:	Wilson	TOLERANCE	Mason	DATE	11.05.2014
APPD:	Schumi			FINISH	Jamy		Sheet No.	2 from 4	Customer:

www.edcon-components.com

email: info@edcon-components.com

EDCON-COMPONENTS



Ordering Informations

Serie	Range Code	Voltage	ROHS	Packing						
-------	------------	---------	------	---------	--	--	--	--	--	--

R25004	-	0A500	A	R	BL					
---------------	---	--------------	----------	----------	-----------	--	--	--	--	--

0A500= 500mA	A= 250VAC	R= ROHS Conform	BL Bulk-Ware long Lead
			B4= Bulk- Ware lead length 4mm
			TR= Tape Reel 1000PCS standard

8,5mm Round Fuse Time Lag
Part No.: R25004
Customer:

DRW:	Jason	CHKD	Wilson	MATL:	Wilson	TOLERANCE	Mason	DATE	11.05.2014
APPD:	Schumi			FINISH	Jamy		Sheet No.		3 from 4



Soldering Profile Curve

Classification Reflow Profile (JEDEC J-STD-020C)



**8,5mm Round Fuse
Time Lag**

Part No.: **R25004**

DRW:	Jason	CHKD	Wilson	MATL:	Wilson	TOLERANCE	Mason	DATE	11.05.2014
APPD:	Schumi			FINISH	Jamy		Sheet No.	4 from 4	Customer: