

# EDCON-COMPONENTS



## Technical Discription

<b>Standard:</b>	IEC 60127, GB 9364
Operating Temperature:	. -55°C ~ + 125°C
Storage Temperature:	. -55°C ~ + 85°C
Solderability:	245°C ± 5°C 5sec ± 0,5sec
Resistance to Soldering Head:	260°C, 10s. Max.
<b>Electrical Characteristics:</b>	
2,1In	Max. 30 minutes
2,75In	Min 10ms
	Max. 3 seconds
4In	Min. 3ms
	Max. 300ms
10In	Max. 20ms
<b>Interrupting Capacity</b>	
CCC/ CQC /SEMKO / VDE / UR / BSI	35A or 10In 50VAC wichever is greater
PSE 100A 250 VAC	
<b>Range Code:</b>	<b>0A800</b>
<b>Range:</b>	<b>0A800= 800mA</b>

## Drawing (mm)

Short Lead

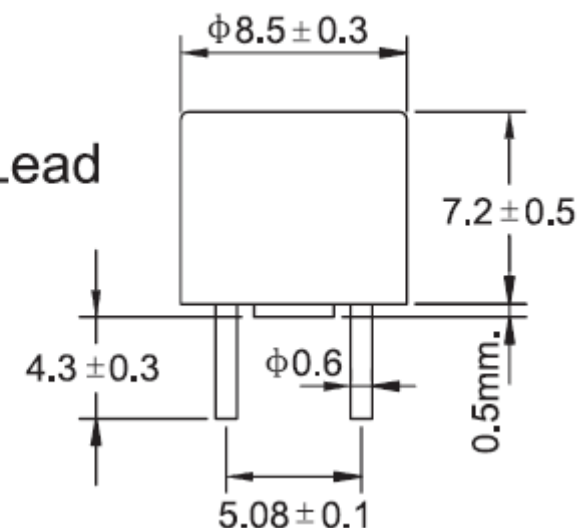

## TAPE-Box-Packing

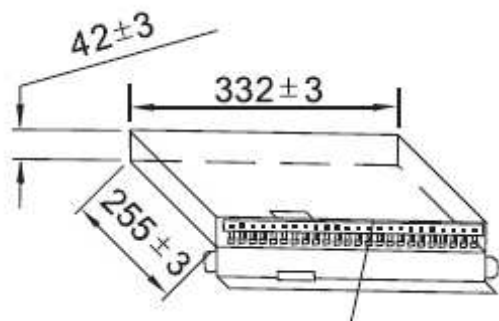

## Approvals

CCC	YES
CQC	
SEMKO	YES
VDE	YES
Urus	YES
PSE	

**8,5mm Round Fuse  
Quick Acting**

Part No.: **R25003**

DRW:	Jason	CHKD	Wilson	MATL:	Wilson	TOLERANCE	Mason	DATE	11.05.2014
APPD:	Schumi			FINISH	Jamy		Sheet No.		1 from 4

Customer:

# EDCON-COMPONENTS



Current Characteristics Curve

Tape/Box Packing

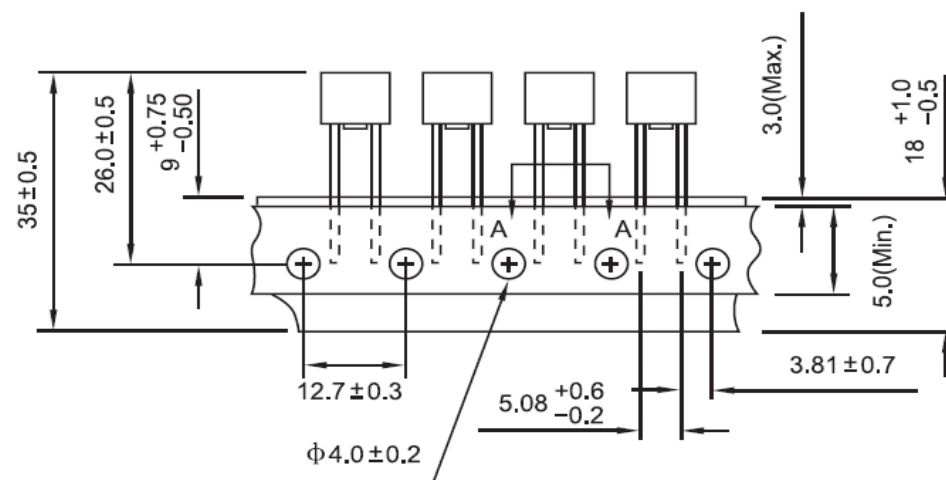
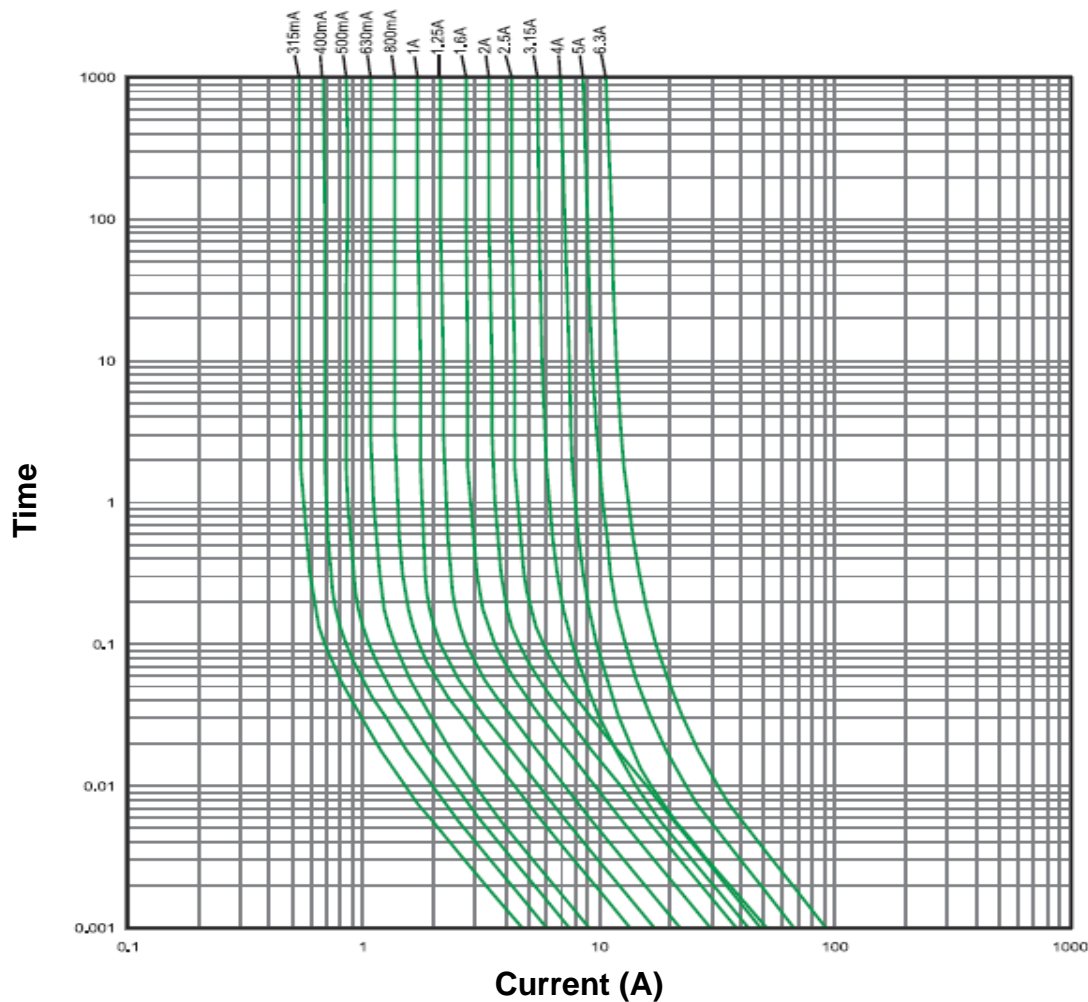

**8,5mm Round Fuse  
Quick Acting**

Part No.: **R25003**

DRW:	Jason	CHKD	Wilson	MATL:	Wilson	TOLERANCE	Mason	DATE	11.05.2014
APPD:	Schumi			FINISH	Jamy		Sheet No.	2 from 4	Customer:

[www.edcon-components.com](http://www.edcon-components.com)

email: [info@edcon-components.com](mailto:info@edcon-components.com)

# EDCON-COMPONENTS



## Ordering Informations

Serie	Range Code	Voltage	ROHS	Packing						
-------	------------	---------	------	---------	--	--	--	--	--	--

<b>R25003</b>	-	<b>0A800</b>	<b>A</b>	<b>R</b>	<b>BL</b>					
---------------	---	--------------	----------	----------	-----------	--	--	--	--	--

<b>0A800=</b> 800mA	<b>A=</b> 250VAC	<b>R=</b> ROHS Conform	<b>BL</b> Bulk-Ware long Lead
			<b>B4=</b> Bulk- Ware lead length 4mm
			<b>TR=</b> Tape Reel 1000PCS standard

<b>8,5mm Round Fuse Quick Acting</b>
Part No.: <b>R25003</b>
Customer:

DRW:	Jason	CHKD	Wilson	MATL:	Wilson	TOLERANCE	Mason	DATE	11.05.2014
APPD:	Schumi			FINISH	Jamy		Sheet No.		3 from 4



Soldering Profile Curve

Classification Reflow Profile (JEDEC J-STD-020C)



**8,5mm Round Fuse  
Quick Acting**

Part No.: **R25003**

DRW:	Jason	CHKD	Wilson	MATL:	Wilson	TOLERANCE	Mason	DATE	11.05.2014
APPD:	Schumi			FINISH	Jamy		Sheet No.	4 from 4	Customer: