

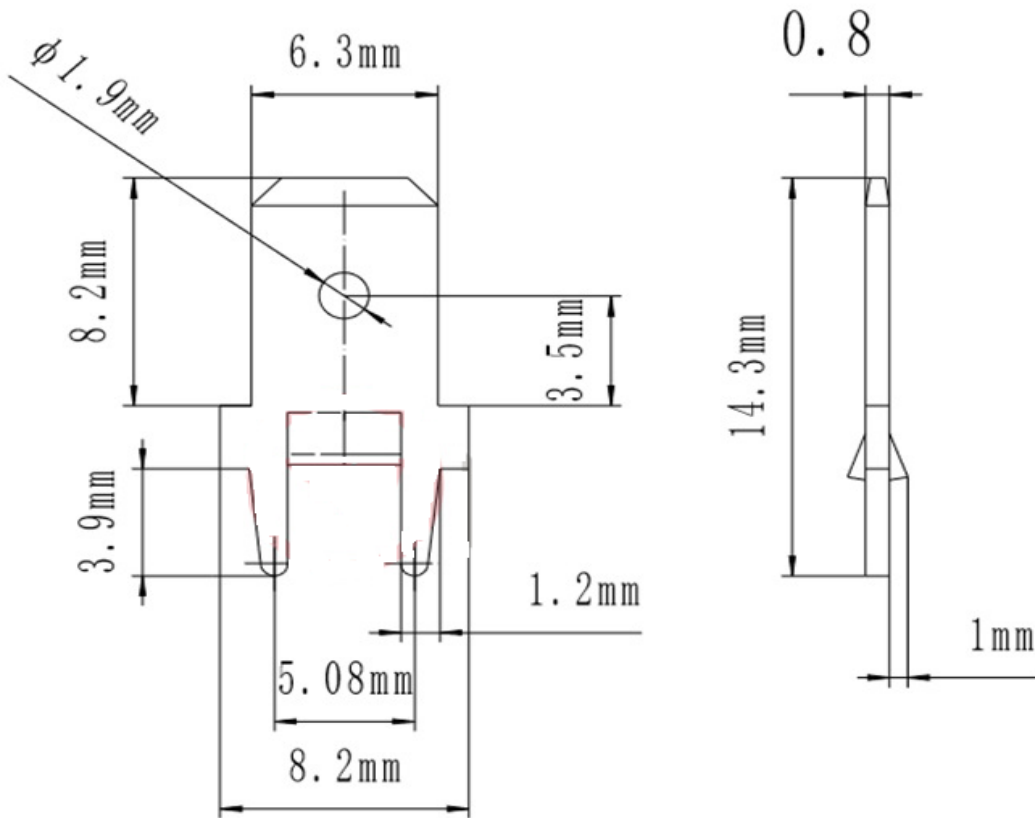

Technical Specification

Mounting : 6,3mm
 Material: Spring Brass
 Rated Voltage: 250V
 Rated Current: Max. 6,3A
 Packing: Bulk
 Thickness: 0,8mm Ni Plated
 Standoff: Yes



Ordering Information

Serie	Contact Plating	Special function	ROHS	Packing		
N40069	TN	N	R	BU		

TN= TIN Plated	N= NO Function	R= ROHS Conform N= NON ROHS Conform	BU = Bulk-Ware
----------------	----------------	--	----------------

6,3mm TAB Terminal	
Part No.:	N40069
Customer:	

DRW:	Jason	CHKD	Jules	MATL:	Wu	DATE	09.04.2019
APPD:	Join			FINISH	Shieh	Sheet	1 from 1