

Data Sheet

(Header) of Pluggable Terminal Block

Pitch: 3,50 mm

Serie: A14G169

Customer Information for special Item

EDCON Customer : 0

Customer Version No. : 0

EDCON-COMPONENTS

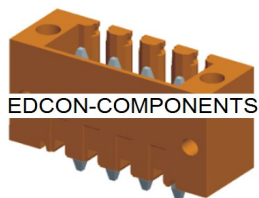

Technical Description

Group UL / CUL	B	C	D
Rated Voltage: (V)	300		300
Rated Current: (A)	10		10
Wire Range:			
Solid: (AWG)			
Stranded: (AWG)			
Withstanding Voltage:	1600V/1Min		
Technical Data IEC (VDE)	III	III	II
Contamination Class	3	2	2
Rated Voltage: (V)	-	160	320
Rated Current: (A)	-	13	13
Withstandin Voltage impulse: (KV)	-	2,5	2,5
Conductor Cross Section			
Solid: (mm ²)			
Flexible: (mm ²)			
Material:			
Insulation Material:	PA66		
Imflamability:	UL94V-0		
Contact Material:	Copper Alloy		
surface Plating:	Tin plated		
Other Data			
Pitch: (mm)	3,5		
No of Poles: (P)	1x2 ~1x24		
Stripping Length: (mm)			
Screw: (Nm)			
Operating Temperature: (°C)	-40C to +105		
Pin Dimensions (mm)	3,2		
PCB Hole Diameter:(mm)	1,6		

Drawing (Dimension in mm)

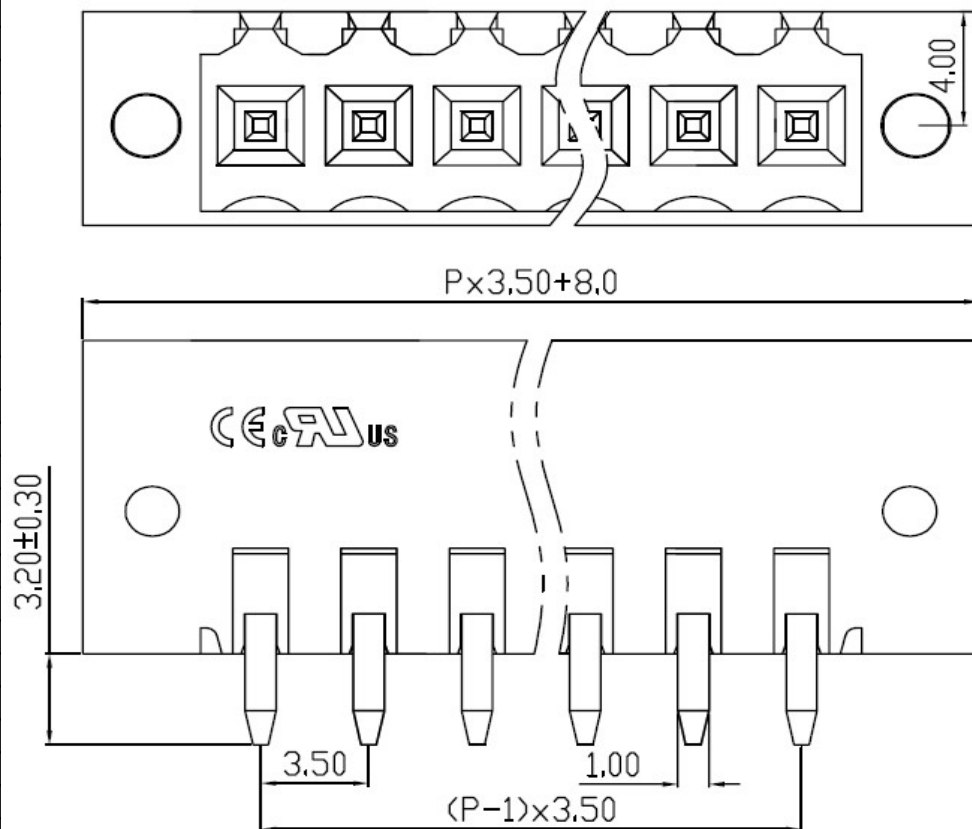

(Header) of Pluggable Terminal Block

Part No.: **A14G169**

DRW:	Jason	CHKD	Wilson	MATL:	Wilson	TOLERANCE	Mason	DATE	04.12.2022
APPD:	Schumi			FINISH	Jamy		Sheet No.		1 from 4

Customer:

www.edcon-components.com

email: info@edcon-components.com

EDCON-COMPONENTS

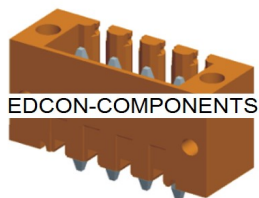

PCB Layout

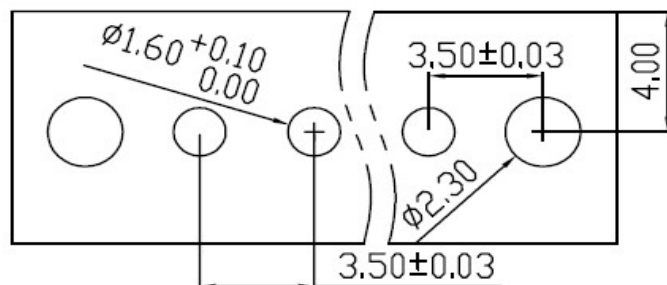

Dimensions (mm)

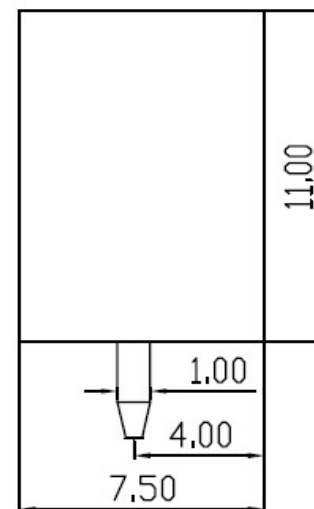

linear dimension (Tolerances Standard GB/T 14486-2008)								—	▱	⊥
variable range	to 6	over 6 to 10	over 10 to 30	over 30 to 60	over 60 to 100	over 100 to 160	over 160 to	to 10	over 10 to 100	over 100 to
tolerance	±0.20	±0.30	±0.50	±0.70	±1.00	±1.30	±1.60	0.10	0.30	0.60

(Header) of Pluggable Terminal Block	
Part No.:	A14G169
Customer:	

DRW:	Jason	CHKD:	Wilson	MATL:	Wilson	TOLERANCE:	Mason	DATE:	04.12.2022
APPD:	Schumi			FINISH:	Jamy		Sheet No.		2 from 4

www.edcon-components.com

email: info@edcon-components.com

EDCON-COMPONENTS

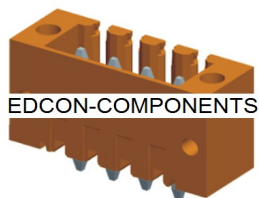

Ordering Informations

Serie	No. of Pos.	Body Color	No Function	Approval Code	ROHS	Packing	EDCON Cust. No.	Customer Version		
-------	-------------	------------	-------------	---------------	------	---------	-----------------	------------------	--	--

A14G169	02	OR	N	A	R	B				
----------------	-----------	-----------	----------	----------	----------	----------	--	--	--	--

Pitch
3,50

02 = Number of Pos.		N = No function	N = NON Approval A = UL /UR Approval Please consult EDCON for available B = VDE Approval Please consult EDCON for available C = TÜV Approval Please consult EDCON for available	R = ROHS Conform N = NON ROHS Conform I = Individual Package	B = Bulk-Ware 	xxxxxx = Customer Number	xxx = Customer Version ??(Printing)
Standard 2 ~ 24 Pos.							
		OR = Orange					

(Header) of Pluggable Terminal Block	
Part No.:	A14G169
Customer:	

DRW:	Jason	CHKD	Wilson	MATL:	Wilson	TOLERANCE	Mason	DATE	04.12.2022
APPD:	Schumi			FINISH	Jamy		Sheet No.	3 from 4	

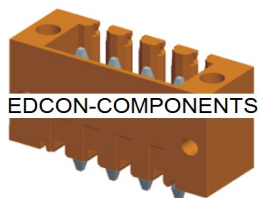

Soldering Profile Curve

Classification Reflow Profile (JEDEC J-STD-020C)

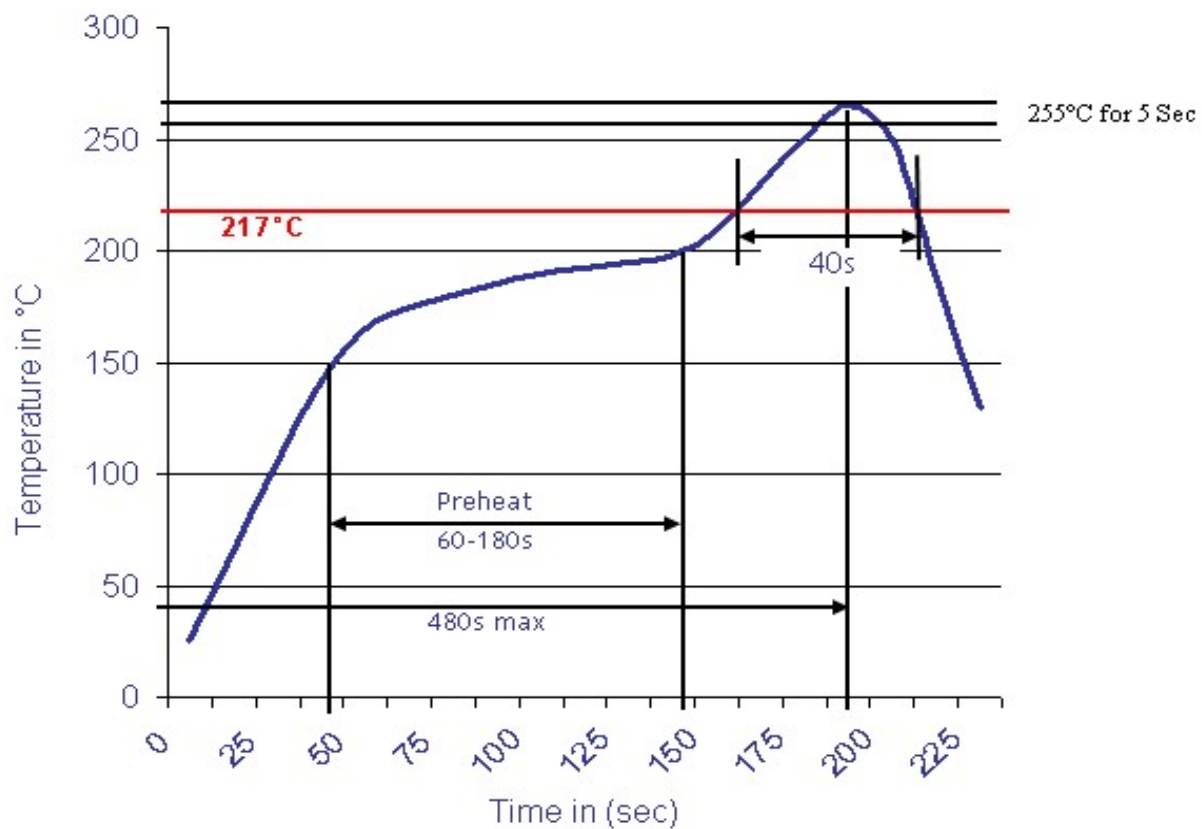

(Header) of Pluggable Terminal Block	
Part No.:	A14G169
Customer:	

DRW:	Jason	CHKD	Wilson	MATL:	Wilson	TOLERANCE	Mason	DATE	04.12.2022
APPD:	Schumi			FINISH	Jamy		Sheet No.	4 from 4	