

# Data Sheet

## Screwless Terminal Block Pitch 5,00mm

**Pitch: 5.00 mm**

**Serie: A11L078**

### Customer Information for special Item

**EDCON Customer : xxxxxx**

**Customer Version No. : xx**

# EDCON-COMPONENTS

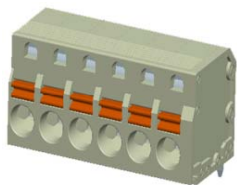

## Technical Discription

### Electrical:

Rated voltage:  
Rated current:  
Withstanding Voltage: AC/1min:  
Operating Temperature:

UL	IEC	VDE
300V	300V	
20A	20A	
2000V	2000V	

-40°C ~ +105°C

### Mechanical:

Strip length: mm  
Wire range: Solid wire: AWG  
Wire range: Stranded wire:AWG

9~10mm	9~10mm	
28~12	2,5mm <sup>2</sup>	

### Material:

Housing Terminal Body: PA66 UL94V-0  
Housing Left-side: PA66 UL94V-0  
Housing Right side: PA66 UL94V-0  
Lever:  
Terminal: Copper Matte Tin plated over Nickel  
Spring Clamp: Stainless steel

## Drawing (Dimension in mm)

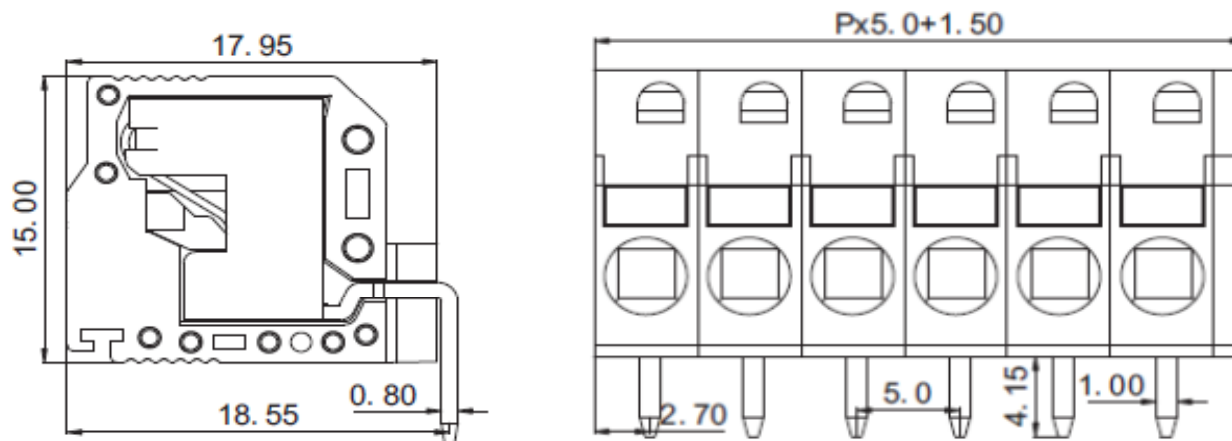

Item No.		
1		
2		
3		
4		
5		
6		
7		
8		
9		

Tolerances unless otherwise specified (mm)				
X	X.X	X.XX	X.XXX	Angle
±	±	±	±	±3°
DRW:	Jason	CHKD	Wilson	MATL:
APPD:	Schumi		FINISH	Jamy

<b>Screwless Terminal Block Pitch 5,00mm</b>	
Part No.:	<b>A11L078</b>
Customer:	

DRW:	Jason	CHKD	Wilson	MATL:	Wilson	TOLERANCE	Mason	DATE	08.01.2021
APPD:	Schumi		FINISH	Jamy				Sheet No.	1 from 4

# EDCON-COMPONENTS

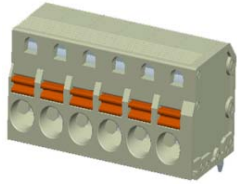

**PCB Layout Dimension (mm)**  
TOP-VIEW

**Dimensions (mm)**

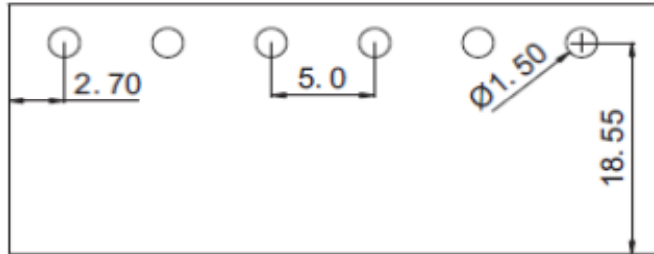

Frontside

**Screwless Terminal Block Pitch  
5,00mm**

Part No.: **A11L078**

Customer:

DRW:	Jason	CHKD	Wilson	MATL:	Wilson	TOLERANCE	Mason	DATE	08.01.2021
APPD:	Schumi			FINISH	Jamy		Sheet No.	2 from 4	

[www.edcon-components.com](http://www.edcon-components.com)

email: [info@edcon-components.com](mailto:info@edcon-components.com)

# EDCON-COMPONENTS

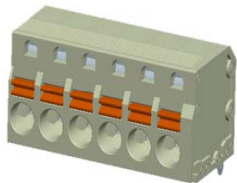

## Ordering Informations

Serie	No. of Pos.	Body Color	Srew Type	Approval Code	ROHS	Packing	EDCON Cust. No.	Customer Version		
<b>A11L078</b>	<b>02</b>	<b>LG</b>	<b>C</b>	<b>N</b>	<b>R</b>	<b>B</b>	<b>xxxxxx</b>	<b>xx</b>		

Pitch
5.00

<b>02</b> = Number of Pos.		<b>C</b> = Screwless Type	<b>N</b> = NON Approval	<b>R</b> = ROHS Conform	<b>B</b> = Standard Package Box/ Polybag <b>I</b> = Individual Package	<b>xxxxxx</b> = Customer Number	<b>xx</b> = Customer Version (Printing) ??
Standard 2 ~ 24Pos.			<b>1</b> = UL-Approval for Body Material	<b>N</b> = NON ROHS Conform			
		<b>LG</b> = Light Gray	<b>A</b> = UL /UR Approval Please consult EDCON for available				
			<b>B</b> = VDE Approval Please consult EDCON for available				
			<b>C</b> = TÜV Approval Please consult EDCON for available				

<b>Screwless Terminal Block Pitch 5,00mm</b>	
Part No.:	<b>A11L078</b>
Customer:	

DRW:	Jason	CHKD	Wilson	MATL:	Wilson	TOLERANCE	Mason	DATE	08.01.2021
APPD:	Schumi			FINISH	Jamy		Sheet No.		3 from 4

[www.edcon-components.com](http://www.edcon-components.com)

email: [info@edcon-components.com](mailto:info@edcon-components.com)

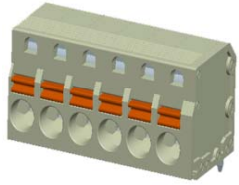

Soldering Profile Curve

Classification Reflow Profile (JEDEC J-STD-020C)

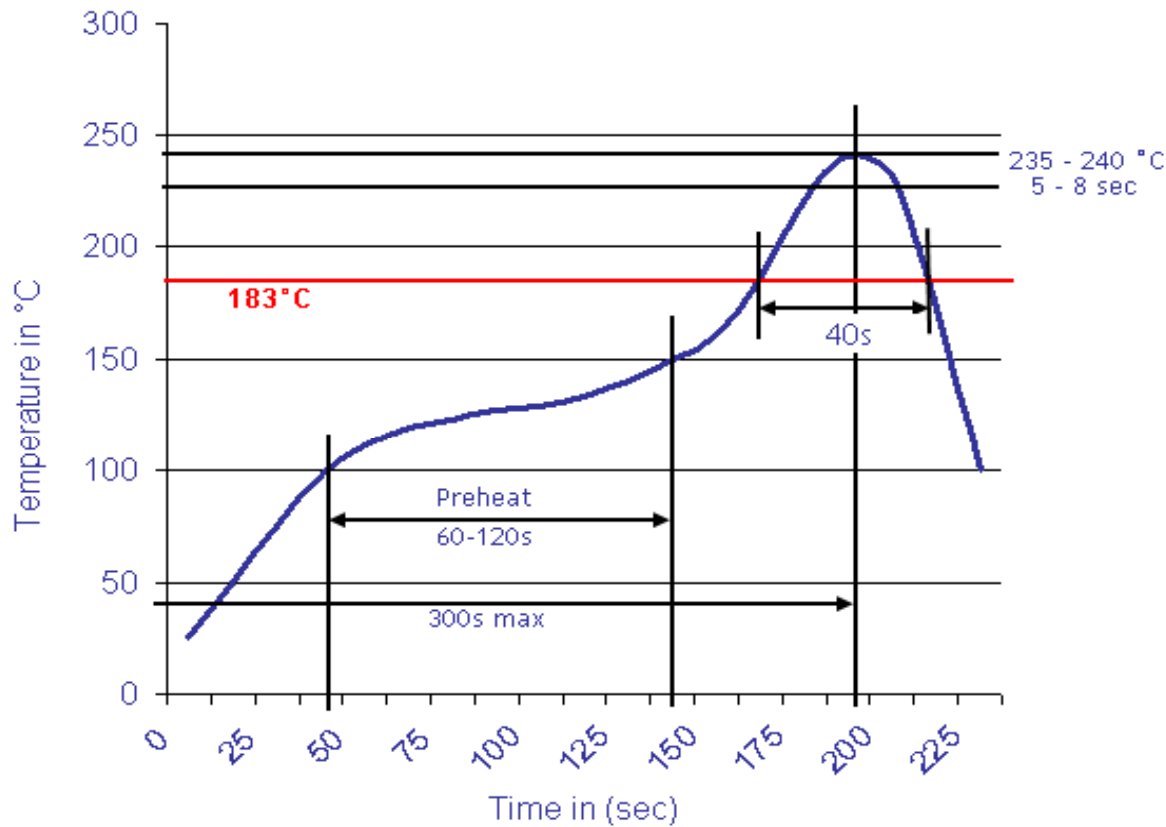

<b>Screwless Terminal Block Pitch 5,00mm</b>	
Part No.:	<b>A11L078</b>
Customer:	

DRW:	Jason	CHKD	Wilson	MATL:	Wilson	TOLERANCE	Mason	DATE	08.01.2021
APPD:	Schumi			FINISH	Jamy		Sheet No.	4 from 4	