

Data Sheet

Screwless Terminal Block

Pitch: 5,00 mm

Serie: A11L007

Customer Information for special Item

EDCON Customer : 0

Customer Version No. : 0

EDCON-COMPONENTS

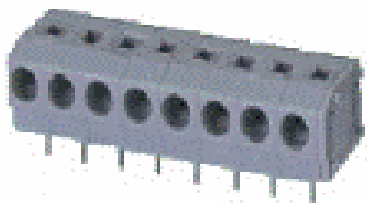

Technical Discription

Drawing (Dimension in mm)

Electrical

Standard
 Rated voltage
 Rated current
 Wire range
 Withstanding voltage

UL	IEC
300V	250V
5A	10A
20-18 AWG	1.5mm ²
AC2000V/1Min	

Mechanical

Wire strip length
 Operating temperature

9 ~ 10mm
 -40°C ~ +105°C

Dimensions

Pitch
 Poles

5.00mm
 1P - xxP

Material

Housing
 Pin header
 Wire guard

PA66 (UL94V-0)
 Phosphor Bronze, Tin plated
 Stainless steel

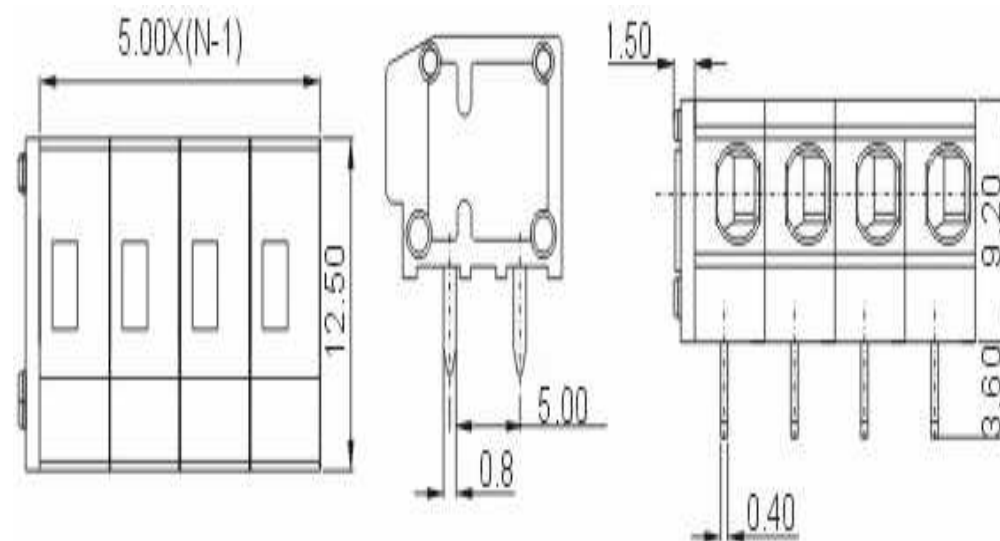

Screwless Terminal Block

Part No.: **A11L007**

Customer:

DRW:	Jason	CHKD	Wilson	MATL:	Wilson	TOLERANCE	Mason	DATE	31.01.2014
APPD:	Schumi			FINISH	Jamy		Sheet No.	1 from 4	

EDCON-COMPONENTS

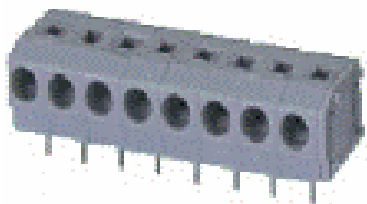

PCB Layout (Dimension in mm)

Dimensions (mm)

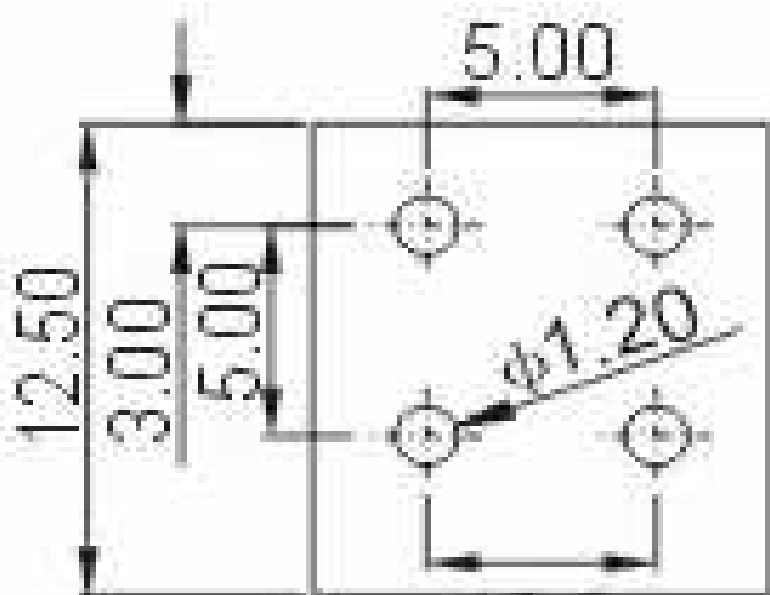

No. of Pos.	A	Tol. P	B	Tol. P
02	11,00	± 0,35	5,00	± 0,35
03	16,00	± 0,35	10,00	± 0,35
04	21,00	± 0,35	15,00	± 0,35
05	26,00	± 0,35	20,00	± 0,35
06	31,00	± 0,35	25,00	± 0,35
07	36,00	± 0,35	30,00	± 0,35
08	41,00	± 0,35	35,00	± 0,35
09	46,00	± 0,35	40,00	± 0,35
10	51,00	± 0,35	45,00	± 0,35
11	56,00	± 0,35	50,00	± 0,35
12	61,00	± 0,35	55,00	± 0,35
13	66,00	± 0,35	60,00	± 0,35
14	71,00	± 0,35	65,00	± 0,35
15	76,00	± 0,35	70,00	± 0,35
16	81,00	± 0,35	75,00	± 0,35
17	86,00	± 0,35	80,00	± 0,35
18	91,00	± 0,35	85,00	± 0,35
19	96,00	± 0,35	90,00	± 0,35
20	101,00	± 0,35	95,00	± 0,35
21	106,00	± 0,35	100,00	± 0,35
22	111,00	± 0,35	105,00	± 0,35
23	116,00	± 0,35	110,00	± 0,35
24	121,00	± 0,35	115,00	± 0,35

Screwless Terminal Block

Part No.: **A11L007**

DRW:	Jason	CHKD	Wilson	MATL:	Wilson	TOLERANCE	Mason	DATE	31.01.2014
APPD:	Schumi			FINISH	Jamy		Sheet No.		2 from 4

Customer:

EDCON-COMPONENTS

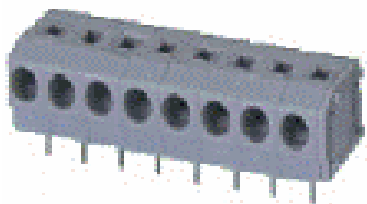

Ordering Informations

Serie	No. of Pos.	Body Color	Approval	Approval Code	ROHS	Packing	EDCON Cust. No.	Customer Version		
A11L007	02	GY	N	N	R	B				

Pitch
5,00

02 = Number of Pos. Standard 2~24 Pos.	GY = Gray (Standard) GN = Green OR = Orange BK = Black	N = No Approval 1 = Approval for Material 2 = Approval for Terminal Block	N = NON Approval A = UL /UR Approval Please consult EDCON for available B = VDE Approval Please consult EDCON for available C = TÜV Approval Please consult EDCON for available	R = ROHS Conform N = NON ROHS Conform	B = Standard Package I = Individual Package	xxxxxx = Customer Number	xxx = Customer Version ??(Printing)
--	---	--	--	--	--	---------------------------------	--

Screwless Terminal Block	
Part No.:	A11L007
Customer:	

DRW:	Jason	CHKD	Wilson	MATL:	Wilson	TOLERANCE	Mason	DATE	31.01.2014
APPD:	Schumi			FINISH	Jamy		Sheet No.		3 from 4

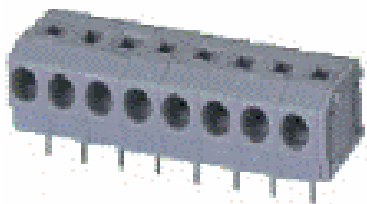

Soldering Profile Curve

Classification Reflow Profile (JEDEC J-STD-020C)

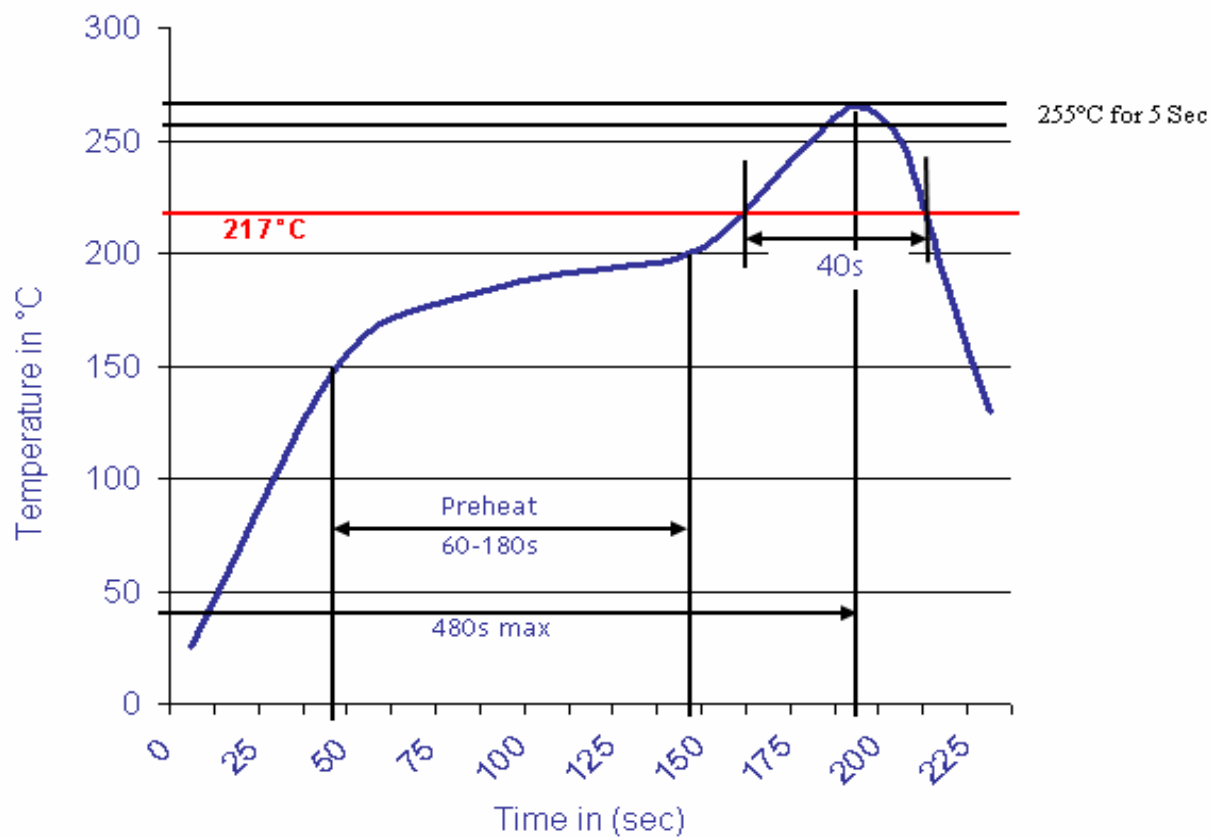

Screwless Terminal Block

Part No.: **A11L007**

Customer:

DRW:	Jason	CHKD	Wilson	MATL:	Wilson	TOLERANCE	Mason	DATE	31.01.2014
APPD:	Schumi			FINISH	Jamy		Sheet No.	4 from 4	

